

**Ball Casters • screwable, plain bearing**

22752.0081



**Product Description**

For positioning and aligning of workpieces.  
Because of the slide bearing, the ball can roll permanently, and the surface of the workpiece is protected.  
At temperatures > 20°C, the carrying figure decreases linearly. (Example: at 90°C the load bearing capacity is max. 60%)

**Material**

**Bearing**  
• plastic

**Ball**  
• Ball-bearing steel, hardened

**Screw**  
• Free cutting steel, blackened

**More information**

**Notes**  
Special types on request.

**Drawing**

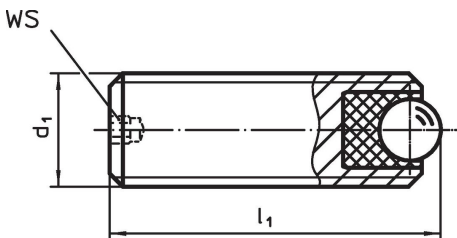

**Order information**

Dimensions			WS [mm]	Static carrying figure C <sub>0</sub> [N]	Tightening torque max. [Nm]	Temperature range		Weight [g]	Art. No.
d <sub>1</sub>	l <sub>1</sub>	Ball diameter [mm]				min.	max.		
<b>Free cutting steel</b>									
M8	10	3.5	1.5	336	0.28	-50	90	2.4	22752.0081

**Application example**

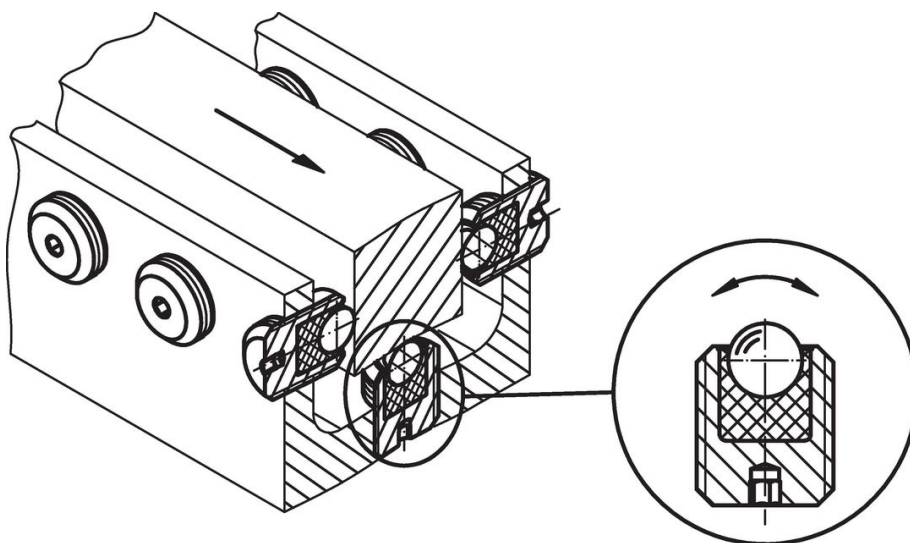

## Compliance

### RoHS compliant

Contains lead - compliant according to exceptions 6a / 6b / 6c.

### Contains SVHC substances >0,1% w/w

Contains lead - SVHC list [REACH] as of 23.01.2024.

### Contains Proposition 65 substances



Lead can cause cancer and reproductive harm from exposure  
<https://www.P65Warnings.ca.gov/>

### Free from Conflict Minerals

This product does not contain any substances designated as "conflict minerals" such as tantalum, tin, gold or tungsten from the Democratic Republic of Congo or adjacent countries.