

Ball Casters · with sheet steel housing

22750.0008



Product Description

Ball casters are module for transport systems, conveyances, to working and packing facilities. For example, parts can be easily moved, turned and controlled.
As from $d_1 = 36$ fitted with an oil drenched felt seal to protect against dirt.

Material

Cap

- Steel, zinc-plated by galvanization

Housing

- Steel, zinc-plated by galvanization

Ball

- Ball-bearing steel

More information

Further products

- Tolerance Rings

Drawing

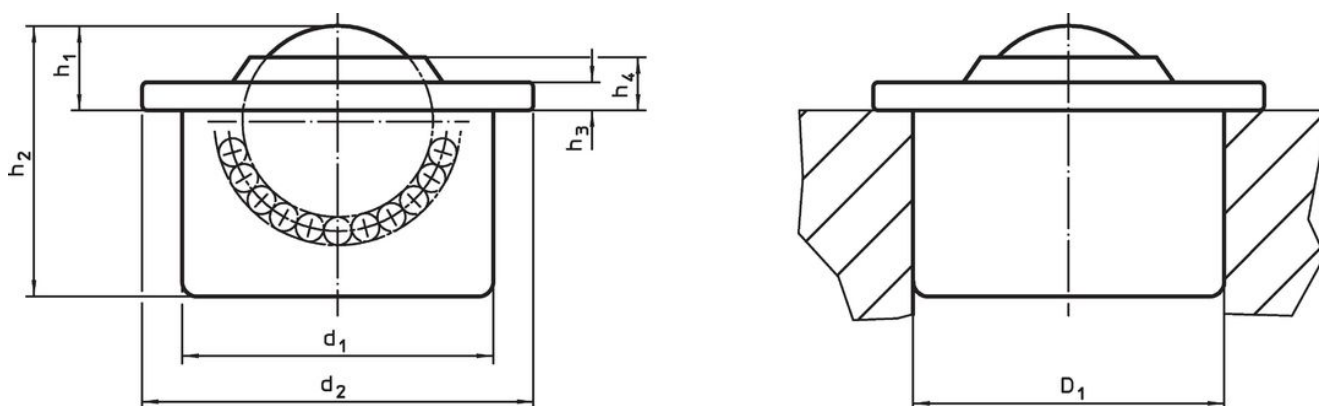

Order information

d_1 ± 0.08	Ball diameter	Dimensions				Location hole D_1 ¹⁾ $+0.05$ [mm]	Dynamic carrying figure C [N]	 [g]	Art. No.	
		d_2	h_1 ± 0.2 [mm]	h_2	h_3					h_4
cap and housing zinc-plated										
36	22	45	9.8	29.5	2.9	5.7	35.9	1300	131	22750.0008

¹⁾ Reference value for 2 mm sheet steel / 5 mm aluminium (force fit)

Application example

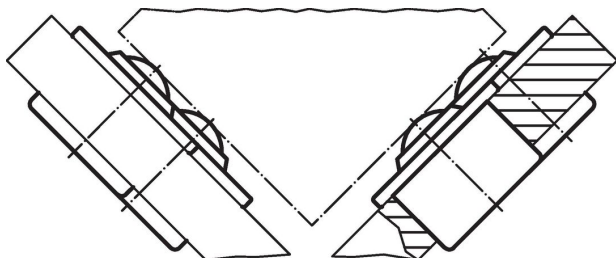



Compliance

RoHS compliant

Compliant according to Directive 2011/65/EU and Directive 2015/863.

Does not contain SVHC substances

No SVHC substances with more than 0.1% w/w contained - SVHC list [REACH] as of 27.06.2024.

Does not contain Proposition 65 substances

No Proposition 65 substances included.

<https://www.P65Warnings.ca.gov/>

Free from Conflict Minerals

This product does not contain any substances designated as "conflict minerals" such as tantalum, tin, gold or tungsten from the Democratic Republic of Congo or adjacent countries.