

## Ball Lock Pins • self-locking, with adjustable handle

22380.0659



### Product Description

For fixing and clamping of two parts or play-free application to the counterpart. Clamping range infinitely variable by hand via nut/lock nut.  
All versions are corrosion resistant. When using stainless steel 1.4542: high-strength, hardened, abrasion resistant pin with high load capacity.

### Material

#### Pin part

- Stainless steel 1.4542, precipitation-hardened

#### Lock nut

- Thermoplastic, black

#### Spring

- Stainless steel

#### Adjusting nut

- Thermoplastic, silver

### Operation

The balls are unlocked by pressing the button.

### Characteristic

Types from stainless steel 1.4542 with marking below the balls.

### More information

### Notes

Special types on request.

### Accessories

Can easily be fitted with retaining cable EH 22400.

### Further products

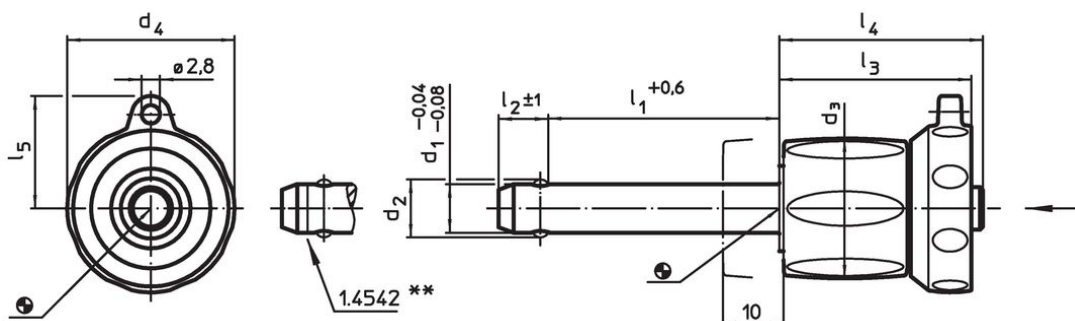

- Locating Bushings, for ball lock pins and socket pins
- Locating Bushings, with flange, for ball lock pins and socket pins
- Retaining Cables
- Positioning Bushings, with collar, DIN 172 A
- Positioning Bushings, without collar, DIN 179 A

### Drawing



\*\* Types from stainless steel 1.4542 with marking.

Order information

Dimensions									Location hole H11	 min.   max.		 [g]	Shearing resistance, two-shear <sup>1)</sup> min. [kN]	Art. No.	
d <sub>1</sub>	l <sub>1</sub>	d <sub>2</sub>	d <sub>3</sub>	d <sub>4</sub>	l <sub>2</sub> ±1	l <sub>3</sub>	l <sub>4</sub>	l <sub>5</sub>		[mm]	[°C]				
-0.04 -0.08	+0.6														
Stainless steel															
16	35 – 45	19	29	34.6	14	36.7	39.5	21.8	16	-30	80	180	257	22380.0659	

<sup>1)</sup> Shearing resistance similar to DIN 50141

Application example





## Compliance

### RoHS compliant

Compliant according to Directive 2011/65/EU and Directive 2015/863.

### Does not contain SVHC substances

No SVHC substances with more than 0.1% w/w contained - SVHC list [REACH] as of 23.01.2024.

### Does not contain Proposition 65 substances

No Proposition 65 substances included.  
<https://www.P65Warnings.ca.gov/>

### Free from Conflict Minerals

This product does not contain any substances designated as "conflict minerals" such as tantalum, tin, gold or tungsten from the Democratic Republic of Congo or adjacent countries.