

## Locating Bushings · for lifting pins

22350.0916



### Product Description

Locating bushings are used for quick and safe locating of lifting pins EH 22350 / EH 22351. Corrosion and abrasion resistant.

### Material

- Stainless steel 1.4542, precipitation-hardened

### Assembly

Safe tolerances and consistent function.  
Easily incorporated into different materials  
Can be mounted in blind holes.  
For thin-walled parts, lock nuts are used for assembly.

### Drawing

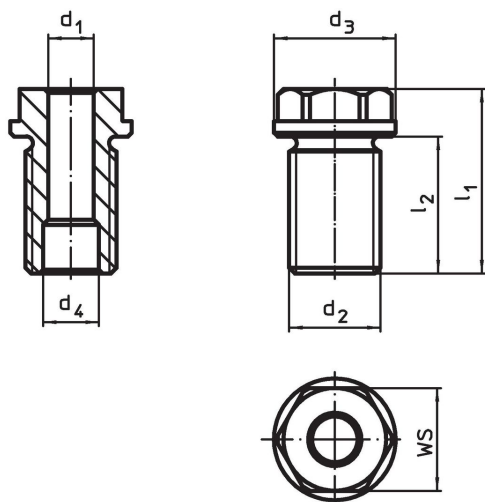

### Order information

Dimensions		For nominal length	Dimensions				WS	Tightening torque max.	x	Load capacity			For lifting pin	Art. No.	
d <sub>1</sub>	d <sub>2</sub>		d <sub>3</sub>	d <sub>4</sub>	l <sub>1</sub>	l <sub>2</sub>				F <sub>1</sub>	F <sub>2</sub>	F <sub>3</sub>			
H11	[mm]	[mm]	-0.2	+0.3	[mm]	[mm]	[mm]	[Nm]	[mm]	[kN]	[kN]	[kN]	[g]		
10	M20	50	28	12.2	65	49	24	130	1.5	2.7	2.4	2.1	22350.0627 / .0727	117	22350.0916

### Application example



### Compliance

#### RoHS compliant

Compliant according to Directive 2011/65/EU and Directive 2015/863.

#### Does not contain SVHC substances

No SVHC substances with more than 0.1% w/w contained - SVHC list [REACH] as of 27.06.2024.

#### Does not contain Proposition 65 substances

No Proposition 65 substances included.

<https://www.P65Warnings.ca.gov/>

#### Free from Conflict Minerals

This product does not contain any substances designated as "conflict minerals" such as tantalum, tin, gold or tungsten from the Democratic Republic of Congo or adjacent countries.