

Captive C-Washers · DIN 6371 with countersunk screw DIN 923

22280.0016



Product Description

Material

Countersunk screw

- Steel, blackened, quality 5.8

Captive C-Washer

- Heat-treated steel, tempered, blackened

Assembly

The captive C-washers can be installed on both sides using the included bolt. You can select either clockwise or anti-clockwise rotation.

Drawing

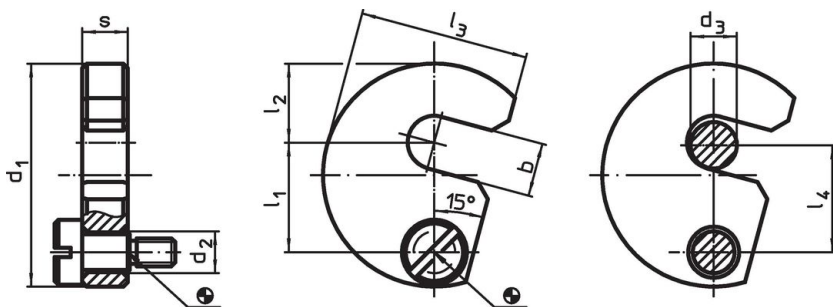

Order information

Nominal size d_3 [mm]	b	d_1	d_2	Dimensions					s -0.2	Suitable screw [mm]	[g]	Art. No.
				l_1	l_2	l_3	l_4	[mm]				
16	17.5	68	11	33.6	25	50	33	11.8	M8 x 12	229	22280.0016	

Application example

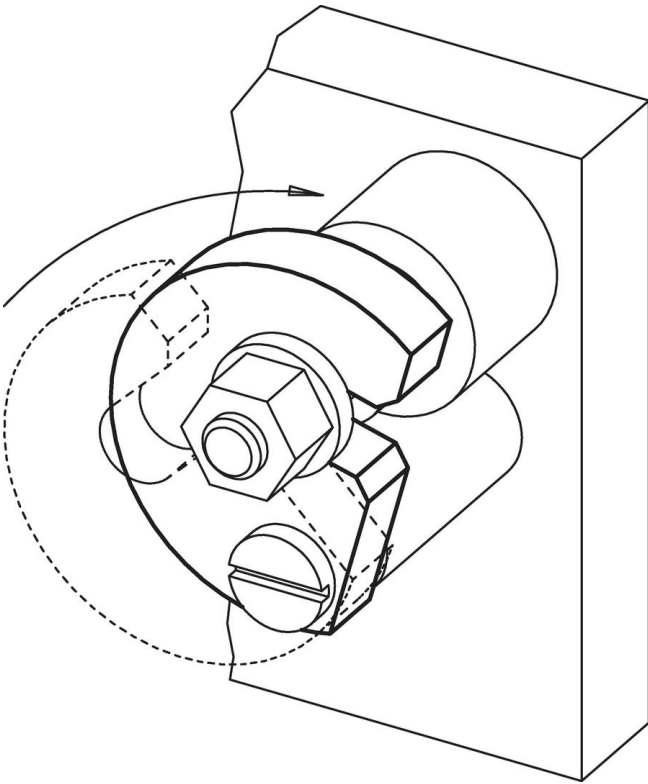

Compliance

RoHS compliant

Compliant according to Directive 2011/65/EU and Directive 2015/863.

Does not contain SVHC substances

No SVHC substances with more than 0.1% w/w contained - SVHC list [REACH] as of 27.06.2024.

Does not contain Proposition 65 substances

No Proposition 65 substances included.
<https://www.P65Warnings.ca.gov/>

Free from Conflict Minerals

This product does not contain any substances designated as "conflict minerals" such as tantalum, tin, gold or tungsten from the Democratic Republic of Congo or adjacent countries.