

## Lateral Plungers · with thread, with seal, with female thread

22150.1460



### Product Description

To be used for positioning and applying pressure, e.g. during painting and sandblasting. Sealed against chips and dirt.

### Material

#### Seal

- CR

#### Body

- Steel, zinc-plated

#### Threaded washer

- Steel, blackened

#### Spring

- Steel, zinc-plated by galvanization

### Assembly

Formula for calculating the center distance for the mounting hole:

$$l_0 = z/2 + w + x,$$

$l_0$  = center distance,

$y$  = workpiece height,

$w$  = workpiece length,

$x$  = stroke,

$z$  = stop diameter

Calculation dimension  $x$  for workpieces:

$$x = d_2/2 - s$$

Lateral plungers are installed by screwing in by means of a mounting tool.

### Characteristic

Version heavy spring load = spring from steel, zinc-plated by galvanization

### More information

### Notes

Individual set screws can be screwed in the plate with threaded hole.

### Drawing

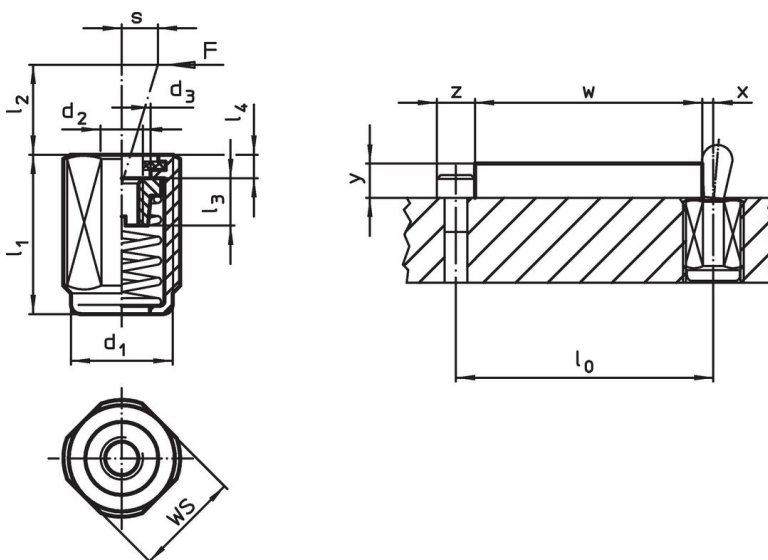

### Order information

Dimensions		Spring load F max. <sup>1)</sup> ~ [N]	d <sub>2</sub>	Dimensions				Stroke s [mm]	WS [mm]	max. [°C]	[g]	Art. No.
d <sub>1</sub> [mm]	l <sub>1</sub> -2			d <sub>3</sub>	l <sub>2</sub>	l <sub>3</sub>	l <sub>4</sub>					
<b>Heavy spring load</b>												
M18 x 1,5	45	200	M6	10.1	16	7.5	2.3	1.6	16	110	32	22150.1460

<sup>1)</sup> statistical average value

### Accessories

	Dimensions d <sub>1</sub> [mm]	[g]	Art. No.
<b>assembly tool</b>			
	M18 x 1,5	137	22150.0822

### Application example



### Compliance

#### RoHS compliant

Contains lead - compliant according to exceptions 6a / 6b / 6c.

#### Contains SVHC substances >0,1% w/w

Contains lead - SVHC list [REACH] as of 27.06.2024.

#### Contains Proposition 65 substances



Lead can cause cancer and reproductive harm from exposure  
<https://www.P65Warnings.ca.gov/>

#### Free from Conflict Minerals

This product does not contain any substances designated as "conflict minerals" such as tantalum, tin, gold or tungsten from the Democratic Republic of Congo or adjacent countries.