

## Index Plungers · without hexagon collar, stainless steel

22120.0476



### Product Description

Index plungers are used for indexing bores.

#### Material

##### Body

- Stainless steel 1.4305

##### Locking pin

- Stainless steel 1.4305, nickel-plated

##### Knob

- Stainless steel 1.4305

#### Assembly

Suitable mounting tools are available.

#### More information

#### Notes

Knob not removable.

Lock nuts have to be purchased separately.

#### Further products

- Mounting Blocks, for index bolts and index plungers, die-cast
- Distance Collars, for index plungers

### Drawing

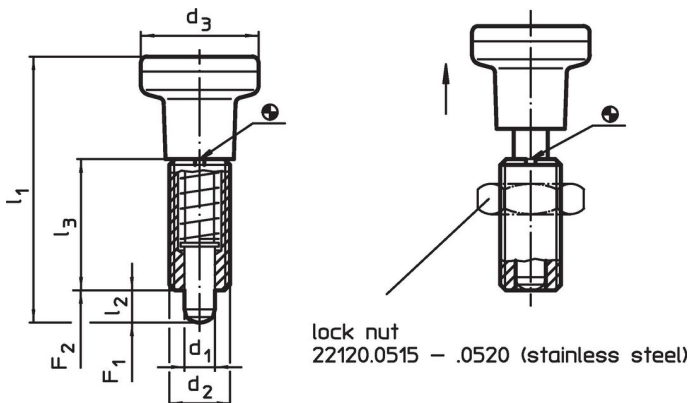



### Order information

Dimensions						Spring load <sup>1)</sup>		🌡️	📦	Art. No.
d <sub>1</sub>	d <sub>2</sub>	d <sub>3</sub>	l <sub>1</sub>	l <sub>2</sub>	l <sub>3</sub>	F <sub>1</sub>	F <sub>2</sub>	max.		
-0.02 -0.05			~	min.		~	~	[°C]		
[mm]						[N]		[°C]	[g]	
Stainless steel										
6	M12 x 1,5	25	54.5	6	26	6.5	19	250	62	22120.0476

<sup>1)</sup> statistical average value

## Accessories

	Dimensions d <sub>2</sub> [mm]	Wrench size [mm]	 [g]	Art. No.
<b>Lock nuts ISO 8675 (DIN 439), Stainless steel</b>				
	M12 x 1,5	18	7.5	22120.0516
<b>assembly tool, Steel</b>				
	M12 x 1,5	-	14.0	22120.0956

## Compliance

### RoHS compliant

Compliant according to Directive 2011/65/EU and Directive 2015/863.

### Does not contain SVHC substances

No SVHC substances with more than 0.1% w/w contained - SVHC list [REACH] as of 27.06.2024.

### Does not contain Proposition 65 substances

No Proposition 65 substances included.  
<https://www.P65Warnings.ca.gov/>

### Free from Conflict Minerals

This product does not contain any substances designated as "conflict minerals" such as tantalum, tin, gold or tungsten from the Democratic Republic of Congo or adjacent countries.