

## Index Bolts 22120.0319



### Product Description

Index bolts are used for indexing purposes.  
Plastic cover for grip allows better handling.

### Material

#### Body

- Free cutting steel, blackened

#### Locking pin

- Steel, hardened

#### Catch

- Free cutting steel, blackened

### Operation

By turning the index bolt 180° the locking pin will be pulled-in and secured by a notched catch (when locking pin should not overhang).

### More information

### Notes

Lock nuts have to be purchased separately.

### Further products

- Mounting Blocks, for index bolts and index plungers, die-cast
- Locating Bushings, for index bolts and index plungers
- Mounting Blocks, for index bolts and index plungers

### Drawing

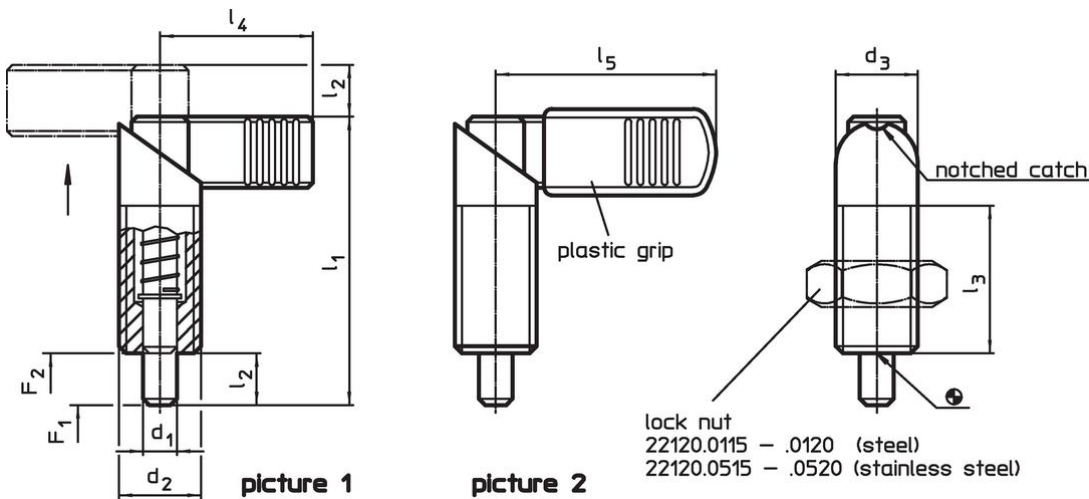



### Order information

Dimensions							Spring load <sup>1)</sup>		max.		Art. No.
d <sub>1</sub>	d <sub>2</sub>	d <sub>3</sub>	l <sub>1</sub>	l <sub>2</sub>	l <sub>3</sub>	l <sub>4</sub>	F <sub>1</sub>	F <sub>2</sub>			
-0.02							~	~			
-0.04											
[mm]							[N]		[°C]	[g]	
without plastic cover for grip – picture 1, Free cutting steel											
10	M16 x 1,5	16	56	10	30	32	11.5	30.5	250	64	22120.0319

<sup>1)</sup> statistical average value

Accessories

	Dimensions d <sub>2</sub> [mm]	Wrench size [mm]	 [g]	Art. No.
<b>Lock nuts ISO 8675 (DIN 439), Steel</b>				
	M16 x 1,5	24	15.0	22120.0118

Compliance

**RoHS compliant**

Contains lead - compliant according to exceptions 6a / 6b / 6c.

**Contains SVHC substances >0,1% w/w**

Contains lead - SVHC list [REACH] as of 23.01.2024.

**Contains Proposition 65 substances**



Lead can cause cancer and reproductive harm from exposure  
<https://www.P65Warnings.ca.gov/>

**Free from Conflict Minerals**

This product does not contain any substances designated as "conflict minerals" such as tantalum, tin, gold or tungsten from the Democratic Republic of Congo or adjacent countries.