

Index Bolts 22120.0316



Product Description

Index bolts are used for indexing purposes. Plastic cover for grip allows better handling.

Material

Body

- Free cutting steel, blackened

Locking pin

- Steel, hardened

Catch

- Free cutting steel, blackened

Operation

By turning the index bolt 180° the locking pin will be pulled-in and secured by a notched catch (when locking pin should not overhang).

More information

Notes

Lock nuts have to be purchased separately.

Further products

- Mounting Blocks, for index bolts and index plungers, die-cast
- Locating Bushings, for index bolts and index plungers
- Mounting Blocks, for index bolts and index plungers

Drawing

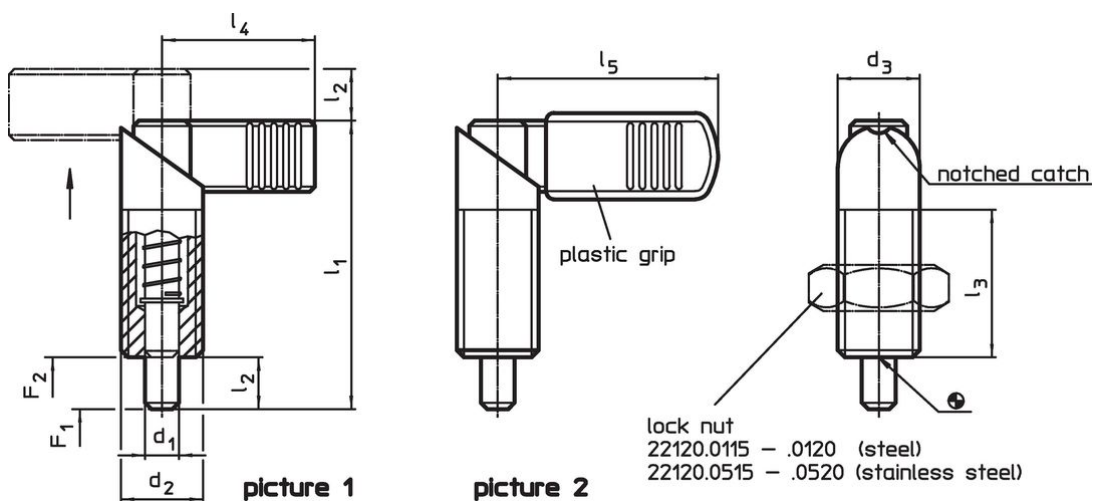



Order information

Dimensions							Spring load ¹⁾		max.		Art. No.
d ₁	d ₂	d ₃	l ₁	l ₂	l ₃	l ₄	F ₁	F ₂			
-0.02							~	~			
-0.04											
[mm]							[N]		[°C]	[g]	
without plastic cover for grip – picture 1, Free cutting steel											
6	M16 x 1,5	16	56	10	30	32	11.5	30.5	250	75	22120.0316

¹⁾ statistical average value

Accessories

	Dimensions d ₂ [mm]	Wrench size [mm]	 [g]	Art. No.
Lock nuts ISO 8675 (DIN 439), Steel				
	M16 x 1,5	24	15.0	22120.0118

Compliance

RoHS compliant

Contains lead - compliant according to exceptions 6a / 6b / 6c.

Contains SVHC substances >0,1% w/w

Contains lead - SVHC list [REACH] as of 27.06.2024.

Contains Proposition 65 substances



Lead can cause cancer and reproductive harm from exposure
<https://www.P65Warnings.ca.gov/>

Free from Conflict Minerals

This product does not contain any substances designated as "conflict minerals" such as tantalum, tin, gold or tungsten from the Democratic Republic of Congo or adjacent countries.