

## Index Plungers Mini Indexes • basic type

22110.0712



### Product Description

Particularly suitable for screwing into thin walled pieces.  
Performance in the smallest space requirements.  
Due to a thread recess the index plungers can be completely screwed in.

### Material

#### Body

- Stainless steel 1.4305

#### Locking pin

- Stainless steel 1.4305

#### Knob

- Thermoplastic PA 6, black, dull

### Assembly

Screw in the mini index. By lifting the knob, the hexagon will be released for assembly.  
The screw length can be adapted by distance collars for index plungers (EH 22120.).

### Operation

When using the self-locking type the knob is pulled-out, turned 30° and secured by a notched catch.

### More information

### Notes

Knob not removable.

### Further products

- Distance Collars, for index plungers

### Drawing

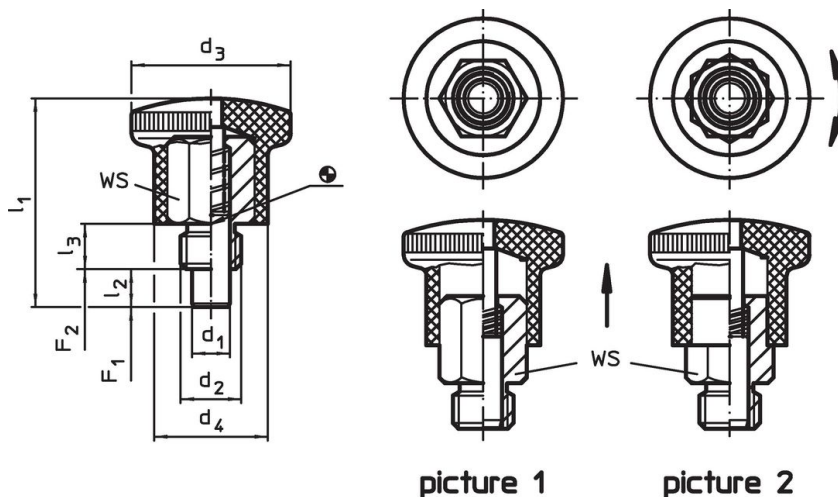

### Order information

Dimensions							WS	Spring load <sup>1)</sup>		Temperature		Weight [g]	Art. No.
d <sub>1</sub> h9	d <sub>2</sub>	d <sub>3</sub>	d <sub>4</sub>	l <sub>1</sub>	l <sub>2</sub> min.	l <sub>3</sub>		F <sub>1</sub> ~	F <sub>2</sub> ~	min.	max.		
[mm]							[mm]	[N]		[°C]		[g]	
without locking – picture 1, Stainless steel													
6	M10 x 1	25	18	34	6	8	12	6	16	-30	80	25	22110.0712

<sup>1)</sup> statistical average value

## Application example



## Compliance

### RoHS compliant

Compliant according to Directive 2011/65/EU and Directive 2015/863.

### Does not contain SVHC substances

No SVHC substances with more than 0.1% w/w contained - SVHC list [REACH] as of 23.01.2024.

### Does not contain Proposition 65 substances

No Proposition 65 substances included.

<https://www.P65Warnings.ca.gov/>

### Free from Conflict Minerals

This product does not contain any substances designated as "conflict minerals" such as tantalum, tin, gold or tungsten from the Democratic Republic of Congo or adjacent countries.