

## Mounting Blocks · for index bolts and index plungers, die-cast

22110.0420



### Product Description

Assembly support and extended application for index bolts and index plungers. Can also be used for locating the locating bushings and positioning bushings EH 22110..

### Material

#### Grub Screw

- Steel, blackened, with brass pad

#### Body

- Zinc die-cast, plastic coated, black

### Assembly

The countersink (t / d<sub>4</sub>) in the thread d<sub>1</sub> is one-sided.

### More information

### Further products

- Locating Bushings, for index bolts and index plungers
- Positioning Bushings, for index bolts and index plungers

### Drawing

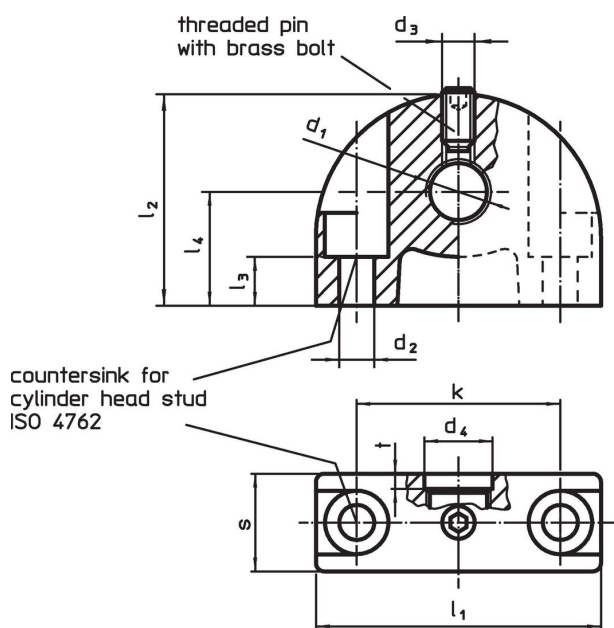

### Order information

Dimensions											max. [°C]	[g]	Art. No.		
d <sub>1</sub>	d <sub>2</sub>	d <sub>3</sub>	d <sub>4</sub>	k	l <sub>1</sub>	l <sub>2</sub>	l <sub>3</sub>	l <sub>4</sub>	s	t					
mounting hole vertical to index bolt and index plunger															
M20 x 1,5	5.3	M5	20.2	35	47	34	15.5	18	14	3	100	68	22110.0420		

## Application example



## Compliance

### RoHS compliant

Compliant according to Directive 2011/65/EU and Directive 2015/863.

### Does not contain SVHC substances

No SVHC substances with more than 0.1% w/w contained - SVHC list [REACH] as of 27.06.2024.

### Does not contain Proposition 65 substances

No Proposition 65 substances included.

<https://www.P65Warnings.ca.gov/>

### Free from Conflict Minerals

This product does not contain any substances designated as "conflict minerals" such as tantalum, tin, gold or tungsten from the Democratic Republic of Congo or adjacent countries.