

Spring Plungers • long version

22070.0634



Product Description

To be used for ejecting, as a detent, for applying pressure or as a shock element.

Material

Pin

- Steel, case-hardened, black

Body

- Heat-treated steel, tempered, blackened

Spring

- Stainless steel

Assembly

Spring plungers can be mounted and removed by means of the slot or internal hexagon. Please use a special assembly tool for mounting with a slot (pin side).

Characteristic

Standard spring load: no marking

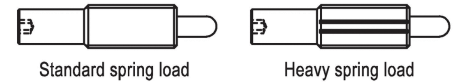

More information

Notes

Customized design on request.
Spring plungers are specially tested for spring range and forces.

References

Thread lock: polyamide all-around coating (for details please refer to the technical appendix).

Drawing

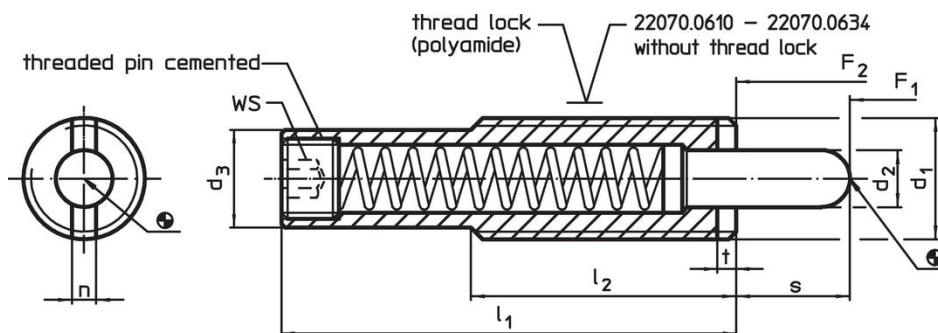

Order information

Dimensions							Stroke s	WS	Spring load ¹⁾		max. [°C]	[g]	Art. No.
d ₁	l ₁	d ₂	d ₃	l ₂	n	t			F ₁	F ₂			
[mm]							[mm]	[mm]	[N]	[N]	[°C]	[g]	
body from heat treated steel, standard spring load, without locking													
M22	226	9	19	50	3.5	4	41	8	76	208	250	358	22070.0634

¹⁾ statistical average value

Accessories

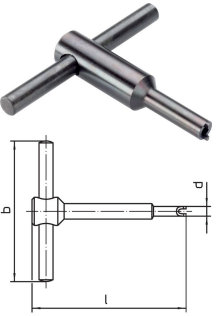
	Dimensions				[g]	Art. No.
	d ₁	b	d	l		
[mm]						
Assembly Tool for mounting via slot (pin sided)						
	M22	100	19.0	100	245	22070.0836

Application example

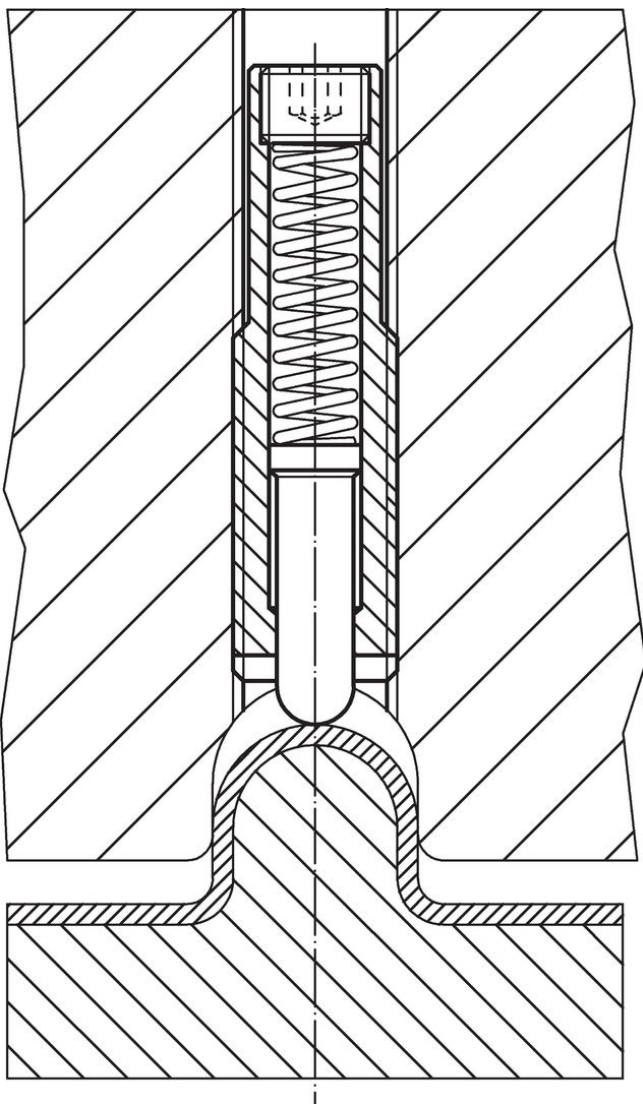

Compliance

RoHS compliant

Compliant according to Directive 2011/65/EU and Directive 2015/863.

Does not contain SVHC substances

No SVHC substances with more than 0.1% w/w contained - SVHC list [REACH] as of 27.06.2024.

Does not contain Proposition 65 substances

No Proposition 65 substances included.

<https://www.P65Warnings.ca.gov/>

Free from Conflict Minerals

This product does not contain any substances designated as "conflict minerals" such as tantalum, tin, gold or tungsten from the Democratic Republic of Congo or adjacent countries.