

Clamping Angles

1906.440



Product Description

Material

- Grey cast iron GG

More information

Notes

Special plates on request.

Further products

- Threaded Lifting Pins, self-locking

Drawing

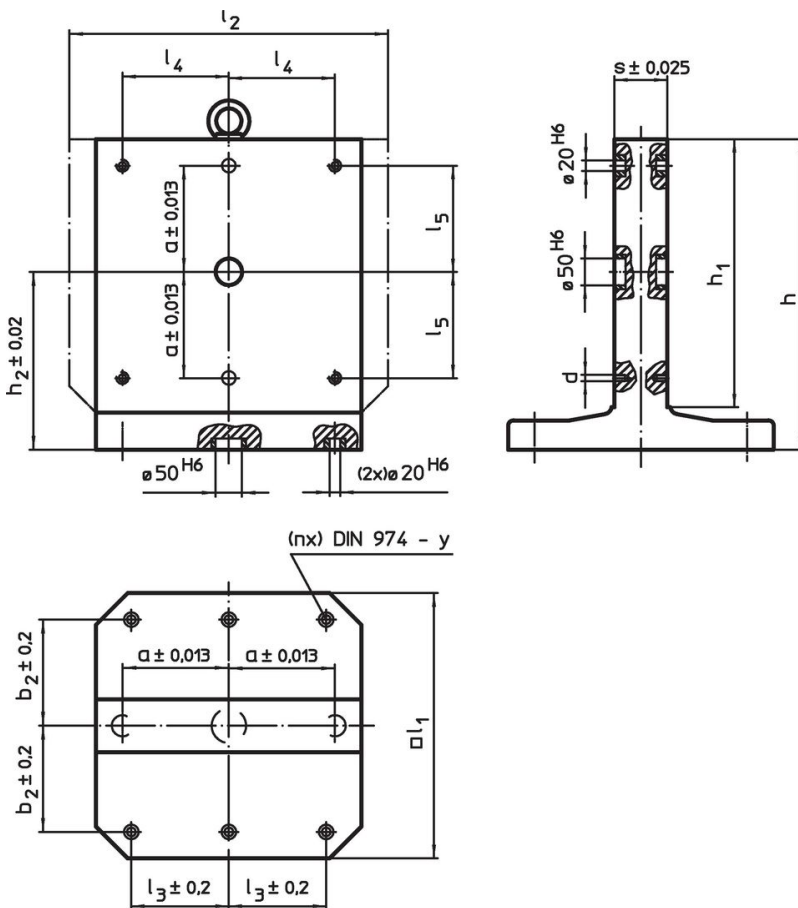

Order information

Dimensions												y	For screws	Number of fastening holes n	 [kg]	Art. No.
l_1	h_1	h	a ± 0.013	b_2 ± 0.2	l_3 ± 0.2	l_4	l_5	h_2 ± 0.02	s ± 0.025	d	[mm]					
500	500	595	200	200	200	200	200	345	100	M12	12	M12	6	295	1906.440	

Application example



Compliance

RoHS compliant

Contains lead - compliant according to exceptions 6a / 6b / 6c.

Contains SVHC substances >0,1% w/w

Contains lead - SVHC list [REACH] as of 23.01.2024.

Contains Proposition 65 substances



Lead can cause cancer and reproductive harm from exposure
<https://www.P65Warnings.ca.gov/>

Free from Conflict Minerals

This product does not contain any substances designated as "conflict minerals" such as tantalum, tin, gold or tungsten from the Democratic Republic of Congo or adjacent countries.