

Clamping Angles · semi-finished
1906.310



Product Description

Material

- Grey cast iron GG

More information

Notes

Special plates on request.

Further products

- Threaded Lifting Pins, self-locking

Drawing

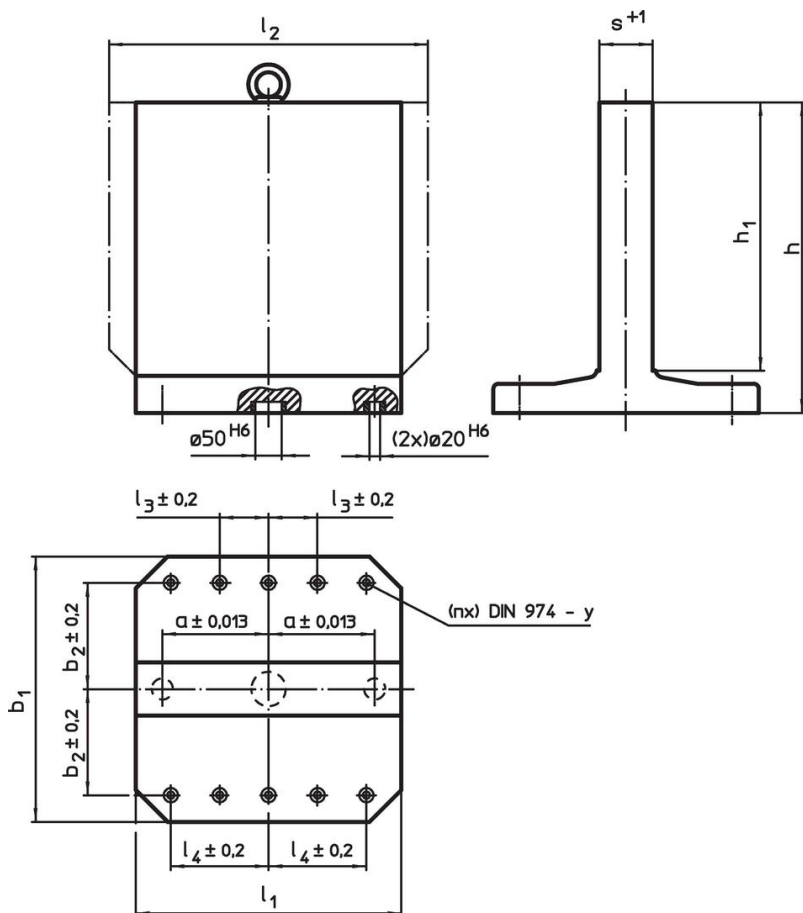

Order information

$b_1 \times l_1$	l_2	h_1	Dimensions					y	For screws	Number of fastening holes n	 [kg]	Art. No.
			h	a ± 0.013	b_2 ± 0.2	l_4 ± 0.2	s $+1$					
Grey cast iron GG												
400 x 400	500	400	475	150	150	150	81	12	M12	4	173	1906.310

Application example

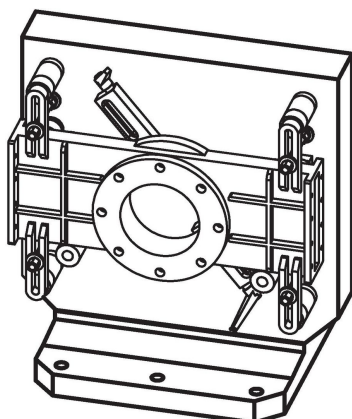

Compliance

RoHS compliant

Contains lead - compliant according to exceptions 6a / 6b / 6c.

Contains SVHC substances >0,1% w/w

Contains lead - SVHC list [REACH] as of 27.06.2024.

Contains Proposition 65 substances



Lead can cause cancer and reproductive harm from exposure
<https://www.P65Warnings.ca.gov/>

Free from Conflict Minerals

This product does not contain any substances designated as "conflict minerals" such as tantalum, tin, gold or tungsten from the Democratic Republic of Congo or adjacent countries.