

Base Plates · V70eco, suitable for pallets DIN 55201

1203.300



Product Description

V70eco base plates are a further development of the established V70 product line, optimized in quality and price.

They are fully compatible with the existing V70 T-slot System.

- Locating holes in quality H6 and slots in quality H8.
- Alignment of the base plate on the machine table by means of locating holes and/or centering slot.
- Fastening holes on a 100 mm pitch.
- High-strength tool steel.

Available options (delivery time approx. 10 working days):

- Additional mounting holes on a 63 mm pitch
- Additional mounting holes on a 125 mm pitch
- Exterior stop
- With connecting rings for Halder Zero-Point Clamping System

Material

- Tool steel, high-strength

More information

Notes

Special types on request.

Drawing

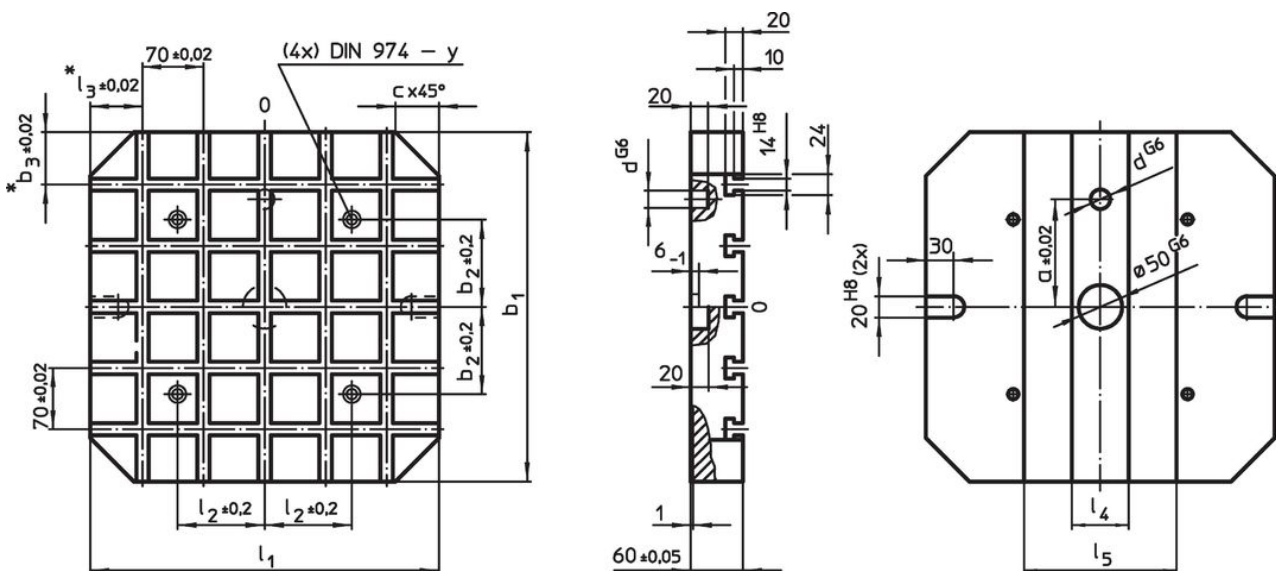

* These tolerances are valid only for optional exterior stop type.

Order information

System	Dimensions												Number of connecting rings Zero-Point Clamping System (optional)	Number of T-slots	[kg]	Art. No.
	l_1	b_1	a ± 0.02	b_2 ± 0.2	b_3 ± 0.02	c	d G6	l_2 ± 0.2	l_3 ± 0.02	l_4	l_5	y				
V70	500	400	150	100	60	50	20	200	40	70	310	12	4	5 x 7	77	1203.300

Compliance

RoHS compliant

Compliant according to Directive 2011/65/EU and Directive 2015/863.

Does not contain SVHC substances

No SVHC substances with more than 0.1% w/w contained - SVHC list [REACH] as of 23.01.2024.

Does not contain Proposition 65 substances

No Proposition 65 substances included.

<https://www.P65Warnings.ca.gov/>

Free from Conflict Minerals

This product does not contain any substances designated as "conflict minerals" such as tantalum, tin, gold or tungsten from the Democratic Republic of Congo or adjacent countries.