

## Čepy s kuličkami • jednočinné - dle NAS / MS17985 EH 4211.



### Popis produktu

Čepy s kuličkami dle MS17985 / NAS1333-1343 se používají k rychlé fixaci, aretaci, přestavení, výměně a zajištění. Rychlá a snadná možnost uvolnění pro často opakovaná spojení.

Čepy s kuličkami (Quick Release Pins) jsou vyrobeny podle letecké normy MS / NAS a testovány podle NAS 1332.

Povrchová úprava:

- Všechny díly z nerezí jsou pasivované podle AMS2700
- Všechny díly z eloxovaného hliníku podle MIL-A-8625

Tepelná úprava:

- Pouzdro: Rc. 40 min. (AMS2759, podmínka H900)
- Čep: Rc. 40 min. (AMS2759, podmínka H900)
- Kulička: Rc. 58-62 min. (AMS2759)

### Materiál

#### Pouzdro

- Nerez, tvrzená, pasivovaná - CRES 17-4PH (specifikace AMS5643)

#### Šroub

- Nerez, tvrzená, pasivovaná - CRES 17-4PH (specifikace AMS5643)

#### Pružina

- Nerez, pasivovaná - CRES 302 (specifikace ASTM-A-313)

#### Držadlo

- Hliník, černá, elox - Slitina hliníku 380 (specifikace ASTM B85/B85)

#### Upevňovací kroužek

- Nerez, pasivovaná - CRES 302 (specifikace ASTM A-313/A313M)

#### Tlačítko

- Nerez, pasivovaná - CRES 303 (specifikace ASTM A484/484M)

#### Kulička

- Nerez, tvrzená, pasivovaná - CRES 440C (specifikace AMS5630)

### Obsluha

Čepy s kuličkami, jednočinné jsou samosvorné. Stisknutím tlačítka se kulička odblokuje.

### Další informace

#### Poznámky

Všechny další rozměry jsou k dispozici na vyžádání.

Jiné kombinace rozměrů a délek, které zde nejsou uvedeny a které odpovídají normě, lze vyrobit na přání zákazníka.



Nestandardní provedení dle poptávky.

- Tento produkt je vyroben v palcových mírách.

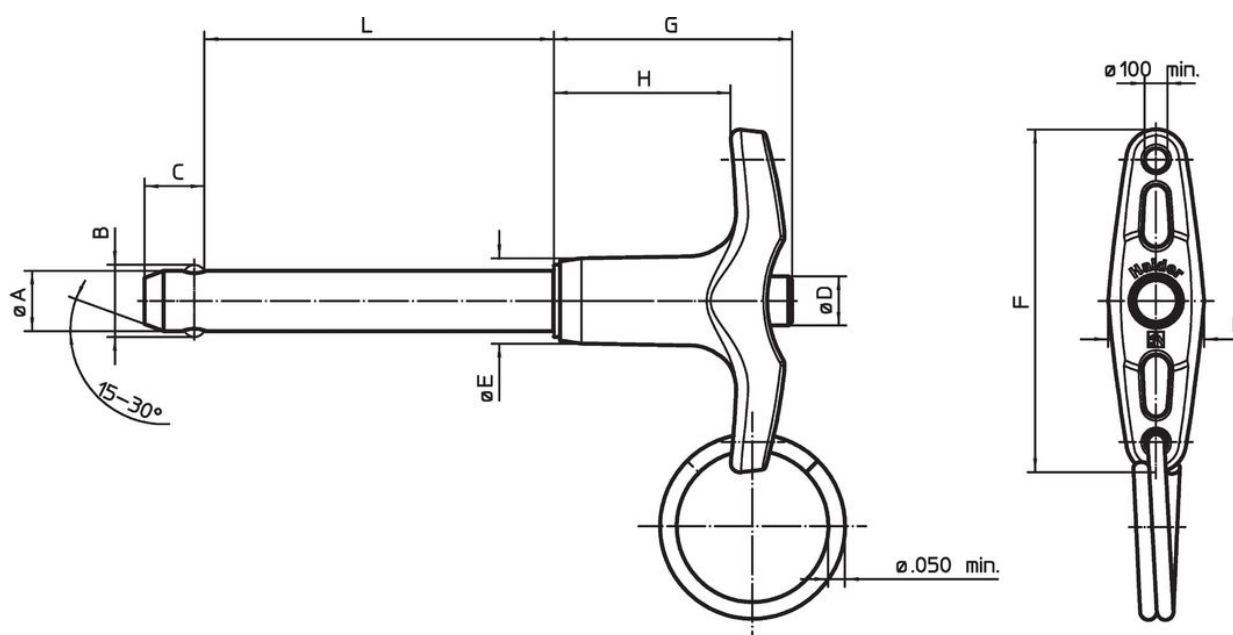

### Výkres s rozměry



Informace pro objednání



Jmenovitý průměr A	A		Upínací délka L +0,02 0	Rozměry						Montážní otvor max.	Pevnost ve stříhu, ve dvou průřezích min.	 min. max.		 [g]	Standardní popis	Obj. č.	
	min.	max.		B ±0,005	C 0 -0,04	D max.	E max.	F max.	G max.			H min.	[palec]				[lbř]
[palec]	[palec]	[palec]	[palec]	[palec]						[palec]	[lbř]	[°F]		[g]			
3/16	0,1870	0,1885	0,3	0,220	0,260	0,310	0,500	1,815	1,27	0,800	0,1940	5.150	-65	200	18,5	MS17985C303 / NAS1333A2C03D	4211.A03
3/16	0,1870	0,1885	0,4	0,220	0,260	0,310	0,500	1,815	1,27	0,800	0,1940	5.150	-65	200	18,8	MS17985C304 / NAS1333A2C04D	4211.A04
3/16	0,1870	0,1885	0,5	0,220	0,260	0,310	0,500	1,815	1,27	0,800	0,1940	5.150	-65	200	19,1	MS17985C305 / NAS1333A2C05D	4211.A05
3/16	0,1870	0,1885	0,6	0,220	0,260	0,310	0,500	1,815	1,27	0,800	0,1940	5.150	-65	200	19,5	MS17985C306 / NAS1333A2C06D	4211.A06
3/16	0,1870	0,1885	0,7	0,220	0,260	0,310	0,500	1,815	1,27	0,800	0,1940	5.150	-65	200	19,8	MS17985C307 / NAS1333A2C07D	4211.A07
3/16	0,1870	0,1885	0,8	0,220	0,260	0,310	0,500	1,815	1,27	0,800	0,1940	5.150	-65	200	20,2	MS17985C308 / NAS1333A2C08D	4211.A08
3/16	0,1870	0,1885	1,0	0,220	0,260	0,310	0,500	1,815	1,27	0,800	0,1940	5.150	-65	200	20,8	MS17985C310 / NAS1333A2C10D	4211.A10
3/16	0,1870	0,1885	1,1	0,220	0,260	0,310	0,500	1,815	1,27	0,800	0,1940	5.150	-65	200	21,2	MS17985C310 / NAS1333A2C11D	4211.A11
3/16	0,1870	0,1885	1,2	0,220	0,260	0,310	0,500	1,815	1,27	0,800	0,1940	5.150	-65	200	21,5	MS17985C312 / NAS1333A2C12D	4211.A12
3/16	0,1870	0,1885	1,3	0,220	0,260	0,310	0,500	1,815	1,27	0,800	0,1940	5.150	-65	200	21,9	MS17985C313 / NAS1333A2C13D	4211.A13
3/16	0,1870	0,1885	1,4	0,220	0,260	0,310	0,500	1,815	1,27	0,800	0,1940	5.150	-65	200	22,2	MS17985C314 / NAS1333A2C14D	4211.A14
3/16	0,1870	0,1885	1,5	0,220	0,260	0,310	0,500	1,815	1,27	0,800	0,1940	5.150	-65	200	22,5	MS17985C315 / NAS1333A2C15D	4211.A15
3/16	0,1870	0,1885	1,6	0,220	0,260	0,310	0,500	1,815	1,27	0,800	0,1940	5.150	-65	200	22,7	MS17985C316 / NAS1333A2C16D	4211.A16
3/16	0,1870	0,1885	2,0	0,220	0,260	0,310	0,500	1,815	1,27	0,800	0,1940	5.150	-65	200	24,2	MS17985C320 / NAS1333A2C20D	4211.A20
3/16	0,1870	0,1885	2,1	0,220	0,260	0,310	0,500	1,815	1,27	0,800	0,1940	5.150	-65	200	24,6	MS17985C321 / NAS1333A2C21D	4211.A21
3/16	0,1870	0,1885	2,2	0,220	0,260	0,310	0,500	1,815	1,27	0,800	0,1940	5.150	-65	200	24,9	MS17985C322 / NAS1333A2C22D	4211.A22
3/16	0,1870	0,1885	2,3	0,220	0,260	0,310	0,500	1,815	1,27	0,800	0,1940	5.150	-65	200	25,3	MS17985C323 / NAS1333A2C23D	4211.A23
3/16	0,1870	0,1885	2,5	0,220	0,260	0,310	0,500	1,815	1,27	0,800	0,1940	5.150	-65	200	25,9	MS17985C325 / NAS1333A2C25D	4211.A25
3/16	0,1870	0,1885	2,6	0,220	0,260	0,310	0,500	1,815	1,27	0,800	0,1940	5.150	-65	200	26,3	MS17985C326 / NAS1333A2C26D	4211.A26
3/16	0,1870	0,1885	4,5	0,220	0,260	0,310	0,500	1,815	1,27	0,800	0,1940	5.150	-65	200	32,7	MS17985C345 / NAS1333A2C45D	4211.A45
3/16	0,1870	0,1885	5,5	0,220	0,260	0,310	0,500	1,815	1,27	0,800	0,1940	5.150	-65	200	-	MS17985C355 / NAS1333A2C55D	4211.A55
3/16	0,1870	0,1885	6,0	0,220	0,260	0,310	0,500	1,815	1,27	0,800	0,1940	5.150	-65	200	37,8	MS17985C360 / NAS1333A2C60D	4211.A60
1/4	0,2470	0,2485	0,5	0,289	0,290	0,310	0,500	1,815	1,27	0,800	0,2540	9.200	-65	200	21,5	MS17985C405 / NAS1334A2C05D	4211.B05
1/4	0,2470	0,2485	0,6	0,289	0,290	0,310	0,500	1,815	1,27	0,800	0,2540	9.200	-65	200	22,1	MS17985C406 / NAS1334A2C06D	4211.B06
1/4	0,2470	0,2485	0,7	0,289	0,290	0,310	0,500	1,815	1,27	0,800	0,2540	9.200	-65	200	22,7	MS17985C407 / NAS1334A2C07D	4211.B07
1/4	0,2470	0,2485	0,8	0,289	0,290	0,310	0,500	1,815	1,27	0,800	0,2540	9.200	-65	200	23,3	MS17985C408 / NAS1334A2C08D	4211.B08
1/4	0,2470	0,2485	0,9	0,289	0,290	0,310	0,500	1,815	1,27	0,800	0,2540	9.200	-65	200	23,9	MS17985C409 / NAS1334A2C09D	4211.B09
1/4	0,2470	0,2485	1,0	0,289	0,290	0,310	0,500	1,815	1,27	0,800	0,2540	9.200	-65	200	24,5	MS17985C410 / NAS1334A2C10D	4211.B10
1/4	0,2470	0,2485	1,1	0,289	0,290	0,310	0,500	1,815	1,27	0,800	0,2540	9.200	-65	200	25,2	MS17985C411 / NAS1334A2C11D	4211.B11
1/4	0,2470	0,2485	1,2	0,289	0,290	0,310	0,500	1,815	1,27	0,800	0,2540	9.200	-65	200	25,8	MS17985C412 / NAS1334A2C12D	4211.B12



Jmenovitý průměr A	A min.	A max.	Upínací délka L +0,02 0	Rozměry						Montážní otvor max.	Pevnost ve stříhu, ve dvou průřezích min.				Standardní popis	Obj. č.	
				B ±0,005	C 0 -0,04	D max.	E max.	F max.	G max.			H min.	min.				max.
[palec]	[palec]	[palec]	[palec]	[palec]						[palec]	[lbf]	[°F]		[g]			
1/4	0,2470	0,2485	1,3	0,289	0,290	0,310	0,500	1,815	1,27	0,800	0,2540	9.200	-65	200	26,4	MS17985C413 / NAS1334A2C13D	4211.B13
1/4	0,2470	0,2485	1,4	0,289	0,290	0,310	0,500	1,815	1,27	0,800	0,2540	9.200	-65	200	27,0	MS17985C414 / NAS1334A2C14D	4211.B14
1/4	0,2470	0,2485	1,5	0,289	0,290	0,310	0,500	1,815	1,27	0,800	0,2540	9.200	-65	200	27,6	MS17985C415 / NAS1334A2C15D	4211.B15
1/4	0,2470	0,2485	1,6	0,289	0,290	0,310	0,500	1,815	1,27	0,800	0,2540	9.200	-65	200	28,2	MS17985C416 / NAS1334A2C16D	4211.B16
1/4	0,2470	0,2485	1,7	0,289	0,290	0,310	0,500	1,815	1,27	0,800	0,2540	9.200	-65	200	28,8	MS17985C417 / NAS1334A2C17D	4211.B17
1/4	0,2470	0,2485	1,8	0,289	0,290	0,310	0,500	1,815	1,27	0,800	0,2540	9.200	-65	200	29,5	MS17985C418 / NAS1334A2C18D	4211.B18
1/4	0,2470	0,2485	2,0	0,289	0,290	0,310	0,500	1,815	1,27	0,800	0,2540	9.200	-65	200	30,7	MS17985C420 / NAS1334A2C20D	4211.B20
1/4	0,2470	0,2485	2,1	0,289	0,290	0,310	0,500	1,815	1,27	0,800	0,2540	9.200	-65	200	31,3	MS17985C421 / NAS1334A2C21D	4211.B21
1/4	0,2470	0,2485	2,3	0,289	0,290	0,310	0,500	1,815	1,27	0,800	0,2540	9.200	-65	200	32,5	MS17985C423 / NAS1334A2C23D	4211.B23
1/4	0,2470	0,2485	2,4	0,289	0,290	0,310	0,500	1,815	1,27	0,800	0,2540	9.200	-65	200	33,1	MS17985C424 / NAS1334A2C24D	4211.B24
1/4	0,2470	0,2485	2,5	0,289	0,290	0,310	0,500	1,815	1,27	0,800	0,2540	9.200	-65	200	33,8	MS17985C425 / NAS1334A2C25D	4211.B25
1/4	0,2470	0,2485	2,6	0,289	0,290	0,310	0,500	1,815	1,27	0,800	0,2540	9.200	-65	200	34,4	MS17985C426 / NAS1334A2C26D	4211.B26
1/4	0,2470	0,2485	2,7	0,289	0,290	0,310	0,500	1,815	1,27	0,800	0,2540	9.200	-65	200	35,0	MS17985C427 / NAS1334A2C27D	4211.B27
1/4	0,2470	0,2485	2,8	0,289	0,290	0,310	0,500	1,815	1,27	0,800	0,2540	9.200	-65	200	35,6	MS17985C428 / NAS1334A2C28D	4211.B28
1/4	0,2470	0,2485	2,9	0,289	0,290	0,310	0,500	1,815	1,27	0,800	0,2540	9.200	-65	200	36,2	MS17985C429 / NAS1334A2C29D	4211.B29
1/4	0,2470	0,2485	3,0	0,289	0,290	0,310	0,500	1,815	1,27	0,800	0,2540	9.200	-65	200	36,8	MS17985C430 / NAS1334A2C30D	4211.B30
1/4	0,2470	0,2485	3,1	0,289	0,290	0,310	0,500	1,815	1,27	0,800	0,2540	9.200	-65	200	37,4	MS17985C431 / NAS1334A2C31D	4211.B31
1/4	0,2470	0,2485	3,2	0,289	0,290	0,310	0,500	1,815	1,27	0,800	0,2540	9.200	-65	200	38,1	MS17985C432 / NAS1334A2C32D	4211.B32
1/4	0,2470	0,2485	3,3	0,289	0,290	0,310	0,500	1,815	1,27	0,800	0,2540	9.200	-65	200	39,0	MS17985C433 / NAS1334A2C33D	4211.B33
1/4	0,2470	0,2485	3,5	0,289	0,290	0,310	0,500	1,815	1,27	0,800	0,2540	9.200	-65	200	39,9	MS17985C435 / NAS1334A2C35D	4211.B35
1/4	0,2470	0,2485	4,0	0,289	0,290	0,310	0,500	1,815	1,27	0,800	0,2540	9.200	-65	200	43,0	MS17985C440 / NAS1334A2C40D	4211.B40
1/4	0,2470	0,2485	5,0	0,289	0,290	0,310	0,500	1,815	1,27	0,800	0,2540	9.200	-65	200	49,1	MS17985C450 / NAS1334A2C50D	4211.B50
1/4	0,2470	0,2485	5,2	0,289	0,290	0,310	0,500	1,815	1,27	0,800	0,2540	9.200	-65	200	50,4	MS17985C452 / NAS1334A2C52D	4211.B52
1/4	0,2470	0,2485	6,0	0,289	0,290	0,310	0,500	1,815	1,27	0,800	0,2540	9.200	-65	200	55,3	MS17985C460 / NAS1334A2C60D	4211.B60
5/16	0,3095	0,3110	0,3	0,375	0,330	0,310	0,500	1,815	1,27	0,800	0,3165	14.400	-65	200	23,1	MS17985C503 / NAS1335A2C03D	4211.C03
5/16	0,3095	0,3110	0,4	0,375	0,330	0,310	0,500	1,815	1,27	0,800	0,3165	14.400	-65	200	24,0	MS17985C504 / NAS1335A2C04D	4211.C04
5/16	0,3095	0,3110	0,5	0,375	0,330	0,310	0,500	1,815	1,27	0,800	0,3165	14.400	-65	200	25,0	MS17985C505 / NAS1335A2C05D	4211.C05
5/16	0,3095	0,3110	0,6	0,375	0,330	0,310	0,500	1,815	1,27	0,800	0,3165	14.400	-65	200	26,0	MS17985C506 / NAS1335A2C06D	4211.C06
5/16	0,3095	0,3110	0,8	0,375	0,330	0,310	0,500	1,815	1,27	0,800	0,3165	14.400	-65	200	27,8	MS17985C508 / NAS1335A2C08D	4211.C08
5/16	0,3095	0,3110	0,9	0,375	0,330	0,310	0,500	1,815	1,27	0,800	0,3165	14.400	-65	200	28,8	MS17985C509 / NAS1335A2C09D	4211.C09
5/16	0,3095	0,3110	1,0	0,375	0,330	0,310	0,500	1,815	1,27	0,800	0,3165	14.400	-65	200	29,7	MS17985C510 / NAS1335A2C10D	4211.C10
5/16	0,3095	0,3110	1,1	0,375	0,330	0,310	0,500	1,815	1,27	0,800	0,3165	14.400	-65	200	30,7	MS17985C511 / NAS1335A2C11D	4211.C11



Jmenovitý průměr A	A min.	A max.	Upínací délka L +0,02 0	Rozměry						Montážní otvor max.	Pevnost ve stříhu, ve dvou průřezích min.				Standardní popis	Obj. č.	
				B ±0,005	C 0 -0,04	D max.	E max.	F max.	G max.			H min.	min.				max.
[palec]	[palec]	[palec]	[palec]	[palec]						[palec]							
5/16	0,3095	0,3110	1,2	0,375	0,330	0,310	0,500	1,815	1,27	0,800	0,3165	14.400	-65	200	31,6	MS17985C512 / NAS1335A2C12D	4211.C12
5/16	0,3095	0,3110	1,3	0,375	0,330	0,310	0,500	1,815	1,27	0,800	0,3165	14.400	-65	200	32,6	MS17985C513 / NAS1335A2C13D	4211.C13
5/16	0,3095	0,3110	1,5	0,375	0,330	0,310	0,500	1,815	1,27	0,800	0,3165	14.400	-65	200	34,5	MS17985C515 / NAS1335A2C15D	4211.C15
5/16	0,3095	0,3110	1,6	0,375	0,330	0,310	0,500	1,815	1,27	0,800	0,3165	14.400	-65	200	35,4	MS17985C516 / NAS1335A2C16D	4211.C16
5/16	0,3095	0,3110	1,8	0,375	0,330	0,310	0,500	1,815	1,27	0,800	0,3165	14.400	-65	200	37,3	MS17985C518 / NAS1335A2C18D	4211.C18
5/16	0,3095	0,3110	2,0	0,375	0,330	0,310	0,500	1,815	1,27	0,800	0,3165	14.400	-65	200	39,2	MS17985C520 / NAS1335A2C20D	4211.C20
5/16	0,3095	0,3110	2,2	0,375	0,330	0,310	0,500	1,815	1,27	0,800	0,3165	14.400	-65	200	41,1	MS17985C522 / NAS1335A2C22D	4211.C22
5/16	0,3095	0,3110	2,3	0,375	0,330	0,310	0,500	1,815	1,27	0,800	0,3165	14.400	-65	200	42,0	MS17985C523 / NAS1335A2C23D	4211.C23
5/16	0,3095	0,3110	2,4	0,375	0,330	0,310	0,500	1,815	1,27	0,800	0,3165	14.400	-65	200	43,0	MS17985C524 / NAS1335A2C24D	4211.C24
5/16	0,3095	0,3110	2,5	0,375	0,330	0,310	0,500	1,815	1,27	0,800	0,3165	14.400	-65	200	43,9	MS17985C525 / NAS1335A2C25D	4211.C25
5/16	0,3095	0,3110	2,6	0,375	0,330	0,310	0,500	1,815	1,27	0,800	0,3165	14.400	-65	200	44,9	MS17985C526 / NAS1335A2C26D	4211.C26
5/16	0,3095	0,3110	2,7	0,375	0,330	0,310	0,500	1,815	1,27	0,800	0,3165	14.400	-65	200	46,0	MS17985C527 / NAS1335A2C27D	4211.C27
5/16	0,3095	0,3110	2,8	0,375	0,330	0,310	0,500	1,815	1,27	0,800	0,3165	14.400	-65	200	46,8	MS17985C528 / NAS1335A2C28D	4211.C28
5/16	0,3095	0,3110	2,9	0,375	0,330	0,310	0,500	1,815	1,27	0,800	0,3165	14.400	-65	200	47,7	MS17985C529 / NAS1335A2C29D	4211.C29
5/16	0,3095	0,3110	3,0	0,375	0,330	0,310	0,500	1,815	1,27	0,800	0,3165	14.400	-65	200	48,7	MS17985C530 / NAS1335A2C30D	4211.C30
5/16	0,3095	0,3110	3,2	0,375	0,330	0,310	0,500	1,815	1,27	0,800	0,3165	14.400	-65	200	50,6	MS17985C532 / NAS1335A2C32D	4211.C32
5/16	0,3095	0,3110	3,3	0,375	0,330	0,310	0,500	1,815	1,27	0,800	0,3165	14.400	-65	200	51,5	MS17985C533 / NAS1335A2C33D	4211.C33
5/16	0,3095	0,3110	3,4	0,375	0,330	0,310	0,500	1,815	1,27	0,800	0,3165	14.400	-65	200	52,4	MS17985C534 / NAS1335A2C34D	4211.C34
5/16	0,3095	0,3110	3,5	0,375	0,330	0,310	0,500	1,815	1,27	0,800	0,3165	14.400	-65	200	53,4	MS17985C535 / NAS1335A2C35D	4211.C35
5/16	0,3095	0,3110	3,8	0,375	0,330	0,310	0,500	1,815	1,27	0,800	0,3165	14.400	-65	200	56,2	MS17985C538 / NAS1335A2C38D	4211.C38
5/16	0,3095	0,3110	4,0	0,375	0,330	0,310	0,500	1,815	1,27	0,800	0,3165	14.400	-65	200	58,1	MS17985C540 / NAS1335A2C40D	4211.C40
5/16	0,3095	0,3110	4,1	0,375	0,330	0,310	0,500	1,815	1,27	0,800	0,3165	14.400	-65	200	59,1	MS17985C541 / NAS1335A2C41D	4211.C41
5/16	0,3095	0,3110	4,2	0,375	0,330	0,310	0,500	1,815	1,27	0,800	0,3165	14.400	-65	200	60,0	MS17985C542 / NAS1335A2C42D	4211.C42
5/16	0,3095	0,3110	4,3	0,375	0,330	0,310	0,500	1,815	1,27	0,800	0,3165	14.400	-65	200	61,0	MS17985C543 / NAS1335A2C43D	4211.C43
5/16	0,3095	0,3110	5,0	0,375	0,330	0,310	0,500	1,815	1,27	0,800	0,3165	14.400	-65	200	67,6	MS17985C550 / NAS1335A2C50D	4211.C50
5/16	0,3095	0,3110	6,0	0,375	0,330	0,310	0,500	1,815	1,27	0,800	0,3165	14.400	-65	200	77,1	MS17985C560 / NAS1335A2C60D	4211.C60
3/8	0,3720	0,3735	0,5	0,440	0,365	0,390	0,625	2,065	1,45	0,850	0,3790	20.700	-65	200	38,1	MS17985C605 / NAS1336A2C05D	4211.D05
3/8	0,3720	0,3735	0,7	0,440	0,365	0,390	0,625	2,065	1,45	0,850	0,3790	20.700	-65	200	40,8	MS17985C607 / NAS1336A2C07D	4211.D07
3/8	0,3720	0,3735	0,8	0,440	0,365	0,390	0,625	2,065	1,45	0,850	0,3790	20.700	-65	200	42,2	MS17985C608 / NAS1336A2C08D	4211.D08
3/8	0,3720	0,3735	0,9	0,440	0,365	0,390	0,625	2,065	1,45	0,850	0,3790	20.700	-65	200	43,5	MS17985C609 / NAS1336A2C09D	4211.D09
3/8	0,3720	0,3735	1,0	0,440	0,365	0,390	0,625	2,065	1,45	0,850	0,3790	20.700	-65	200	44,9	MS17985C610 / NAS1336A2C10D	4211.D10
3/8	0,3720	0,3735	1,1	0,440	0,365	0,390	0,625	2,065	1,45	0,850	0,3790	20.700	-65	200	46,3	MS17985C611 / NAS1336A2C11D	4211.D11

Jmenovitý průměr A	A min.	A max.	Upínací délka L +0,02 0	Rozměry						Montážní otvor max.	Pevnost ve stříhu, ve dvou průřezích min.				Standardní popis	Obj. č.	
				B ±0,005	C 0 -0,04	D max.	E max.	F max.	G max.			H min.	min.				max.
[palec]	[palec]	[palec]	[palec]	[palec]						[palec]	[lbf]	[°F]		[g]			
3/8	0,3720	0,3735	1,2	0,440	0,365	0,390	0,625	2,065	1,45	0,850	0,3790	20.700	-65	200	47,6	MS17985C612 / NAS1336A2C12D	4211.D12
3/8	0,3720	0,3735	1,3	0,440	0,365	0,390	0,625	2,065	1,45	0,850	0,3790	20.700	-65	200	49,0	MS17985C613 / NAS1336A2C13D	4211.D13
3/8	0,3720	0,3735	1,4	0,440	0,365	0,390	0,625	2,065	1,45	0,850	0,3790	20.700	-65	200	50,3	MS17985C614 / NAS1336A2C14D	4211.D14
3/8	0,3720	0,3735	1,5	0,440	0,365	0,390	0,625	2,065	1,45	0,850	0,3790	20.700	-65	200	51,7	MS17985C615 / NAS1336A2C15D	4211.D15
3/8	0,3720	0,3735	1,6	0,440	0,365	0,390	0,625	2,065	1,45	0,850	0,3790	20.700	-65	200	53,1	MS17985C616 / NAS1336A2C16D	4211.D16
3/8	0,3720	0,3735	1,7	0,440	0,365	0,390	0,625	2,065	1,45	0,850	0,3790	20.700	-65	200	54,4	MS17985C617 / NAS1336A2C17D	4211.D17
3/8	0,3720	0,3735	1,8	0,440	0,365	0,390	0,625	2,065	1,45	0,850	0,3790	20.700	-65	200	55,8	MS17985C618 / NAS1336A2C18D	4211.D18
3/8	0,3720	0,3735	1,9	0,440	0,365	0,390	0,625	2,065	1,45	0,850	0,3790	20.700	-65	200	57,1	MS17985C619 / NAS1336A2C19D	4211.D19
3/8	0,3720	0,3735	2,0	0,440	0,365	0,390	0,625	2,065	1,45	0,850	0,3790	20.700	-65	200	58,5	MS17985C620 / NAS1336A2C20D	4211.D20
3/8	0,3720	0,3735	2,1	0,440	0,365	0,390	0,625	2,065	1,45	0,850	0,3790	20.700	-65	200	59,9	MS17985C621 / NAS1336A2C21D	4211.D21
3/8	0,3720	0,3735	2,2	0,440	0,365	0,390	0,625	2,065	1,45	0,850	0,3790	20.700	-65	200	61,2	MS17985C622 / NAS1336A2C22D	4211.D22
3/8	0,3720	0,3735	2,3	0,440	0,365	0,390	0,625	2,065	1,45	0,850	0,3790	20.700	-65	200	63,0	MS17985C623 / NAS1336A2C23D	4211.D23
3/8	0,3720	0,3735	2,4	0,440	0,365	0,390	0,625	2,065	1,45	0,850	0,3790	20.700	-65	200	63,9	MS17985C624 / NAS1336A2C24D	4211.D24
3/8	0,3720	0,3735	2,5	0,440	0,365	0,390	0,625	2,065	1,45	0,850	0,3790	20.700	-65	200	65,3	MS17985C625 / NAS1336A2C25D	4211.D25
3/8	0,3720	0,3735	2,6	0,440	0,365	0,390	0,625	2,065	1,45	0,850	0,3790	20.700	-65	200	66,7	MS17985C626 / NAS1336A2C26D	4211.D26
3/8	0,3720	0,3735	2,7	0,440	0,365	0,390	0,625	2,065	1,45	0,850	0,3790	20.700	-65	200	68,0	MS17985C627 / NAS1336A2C27D	4211.D27
3/8	0,3720	0,3735	2,8	0,440	0,365	0,390	0,625	2,065	1,45	0,850	0,3790	20.700	-65	200	69,4	MS17985C628 / NAS1336A2C28D	4211.D28
3/8	0,3720	0,3735	3,0	0,440	0,365	0,390	0,625	2,065	1,45	0,850	0,3790	20.700	-65	200	72,1	MS17985C630 / NAS1336A2C30D	4211.D30
3/8	0,3720	0,3735	3,1	0,440	0,365	0,390	0,625	2,065	1,45	0,850	0,3790	20.700	-65	200	73,5	MS17985C631 / NAS1336A2C31D	4211.D31
3/8	0,3720	0,3735	3,2	0,440	0,365	0,390	0,625	2,065	1,45	0,850	0,3790	20.700	-65	200	74,8	MS17985C632 / NAS1336A2C32D	4211.D32
3/8	0,3720	0,3735	3,4	0,440	0,365	0,390	0,625	2,065	1,45	0,850	0,3790	20.700	-65	200	77,5	MS17985C634 / NAS1336A2C34D	4211.D34
3/8	0,3720	0,3735	3,5	0,440	0,365	0,390	0,625	2,065	1,45	0,850	0,3790	20.700	-65	200	78,9	MS17985C635 / NAS1336A2C35D	4211.D35
3/8	0,3720	0,3735	4,0	0,440	0,365	0,390	0,625	2,065	1,45	0,850	0,3790	20.700	-65	200	85,7	MS17985C640 / NAS1336A2C40D	4211.D40
3/8	0,3720	0,3735	4,2	0,440	0,365	0,390	0,625	2,065	1,45	0,850	0,3790	20.700	-65	200	89,0	MS17985C642 / NAS1336A2C42D	4211.D42
3/8	0,3720	0,3735	4,5	0,440	0,365	0,390	0,625	2,065	1,45	0,850	0,3790	20.700	-65	200	92,5	MS17985C645 / NAS1336A2C45D	4211.D45
3/8	0,3720	0,3735	4,8	0,440	0,365	0,390	0,625	2,065	1,45	0,850	0,3790	20.700	-65	200	96,6	MS17985C648 / NAS1336A2C48D	4211.D48
3/8	0,3720	0,3735	5,0	0,440	0,365	0,390	0,625	2,065	1,45	0,850	0,3790	20.700	-65	200	99,3	MS17985C650 / NAS1336A2C50D	4211.D50
3/8	0,3720	0,3735	5,5	0,440	0,365	0,390	0,625	2,065	1,45	0,850	0,3790	20.700	-65	200	106,0	MS17985C655 / NAS1336A2C55D	4211.D55
3/8	0,3720	0,3735	6,0	0,440	0,365	0,390	0,625	2,065	1,45	0,850	0,3790	20.700	-65	200	113,0	MS17985C660 / NAS1336A2C60D	4211.D60
7/16	0,4345	0,4360	0,8	0,509	0,380	0,390	0,625	2,065	1,47	0,850	0,4425	28.500	-65	200	48,1	MS17985C708 / NAS1337A2C08D	4211.E08
7/16	0,4345	0,4360	1,0	0,509	0,380	0,390	0,625	2,065	1,47	0,850	0,4425	28.500	-65	200	51,8	MS17985C710 / NAS1337A2C10D	4211.E10
7/16	0,4345	0,4360	1,1	0,509	0,380	0,390	0,625	2,065	1,47	0,850	0,4425	28.500	-65	200	53,6	MS17985C711 / NAS1337A2C11D	4211.E11





Jmenovitý průměr A	A min.	A max.	Upínací délka L +0,02 0	Rozměry						Montážní otvor max.	Pevnost ve stříhu, ve dvou průřezích min.				Standardní popis	Obj. č.	
				B ±0,005	C 0 -0,04	D max.	E max.	F max.	G max.			H min.	min.				max.
[palec]	[palec]	[palec]	[palec]	[palec]						[palec]	[lbf]	[°F]		[g]			
7/16	0,4345	0,4360	1,2	0,509	0,380	0,390	0,625	2,065	1,47	0,850	0,4425	28.500	-65	200	55,5	MS17985C712 / NAS1337A2C12D	4211.E12
7/16	0,4345	0,4360	1,5	0,509	0,380	0,390	0,625	2,065	1,47	0,850	0,4425	28.500	-65	200	61,1	MS17985C715 / NAS1337A2C15D	4211.E15
7/16	0,4345	0,4360	1,6	0,509	0,380	0,390	0,625	2,065	1,47	0,850	0,4425	28.500	-65	200	62,9	MS17985C716 / NAS1337A2C16D	4211.E16
7/16	0,4345	0,4360	1,8	0,509	0,380	0,390	0,625	2,065	1,47	0,850	0,4425	28.500	-65	200	66,7	MS17985C718 / NAS1337A2C18D	4211.E18
7/16	0,4345	0,4360	2,0	0,509	0,380	0,390	0,625	2,065	1,47	0,850	0,4425	28.500	-65	200	70,4	MS17985C720 / NAS1337A2C20D	4211.E20
7/16	0,4345	0,4360	2,1	0,509	0,380	0,390	0,625	2,065	1,47	0,850	0,4425	28.500	-65	200	72,2	MS17985C721 / NAS1337A2C21D	4211.E21
7/16	0,4345	0,4360	2,3	0,509	0,380	0,390	0,625	2,065	1,47	0,850	0,4425	28.500	-65	200	75,9	MS17985C723 / NAS1337A2C23D	4211.E23
7/16	0,4345	0,4360	2,4	0,509	0,380	0,390	0,625	2,065	1,47	0,850	0,4425	28.500	-65	200	77,8	MS17985C724 / NAS1337A2C24D	4211.E24
7/16	0,4345	0,4360	2,5	0,509	0,380	0,390	0,625	2,065	1,47	0,850	0,4425	28.500	-65	200	79,6	MS17985C725 / NAS1337A2C25D	4211.E25
7/16	0,4345	0,4360	2,6	0,509	0,380	0,390	0,625	2,065	1,47	0,850	0,4425	28.500	-65	200	81,5	MS17985C726 / NAS1337A2C26D	4211.E26
7/16	0,4345	0,4360	2,7	0,509	0,380	0,390	0,625	2,065	1,47	0,850	0,4425	28.500	-65	200	83,0	MS17985C727 / NAS1337A2C27D	4211.E27
7/16	0,4345	0,4360	2,8	0,509	0,380	0,390	0,625	2,065	1,47	0,850	0,4425	28.500	-65	200	85,2	MS17985C728 / NAS1337A2C28D	4211.E28
7/16	0,4345	0,4360	2,9	0,509	0,380	0,390	0,625	2,065	1,47	0,850	0,4425	28.500	-65	200	87,1	MS17985C729 / NAS1337A2C29D	4211.E29
7/16	0,4345	0,4360	3,0	0,509	0,380	0,390	0,625	2,065	1,47	0,850	0,4425	28.500	-65	200	88,9	MS17985C730 / NAS1337A2C30D	4211.E30
7/16	0,4345	0,4360	3,1	0,509	0,380	0,390	0,625	2,065	1,47	0,850	0,4425	28.500	-65	200	90,8	MS17985C731 / NAS1337A2C31D	4211.E31
7/16	0,4345	0,4360	3,2	0,509	0,380	0,390	0,625	2,065	1,47	0,850	0,4425	28.500	-65	200	92,6	MS17985C732 / NAS1337A2C32D	4211.E32
7/16	0,4345	0,4360	3,3	0,509	0,380	0,390	0,625	2,065	1,47	0,850	0,4425	28.500	-65	200	94,5	MS17985C733 / NAS1337A2C33D	4211.E33
7/16	0,4345	0,4360	3,6	0,509	0,380	0,390	0,625	2,065	1,47	0,850	0,4425	28.500	-65	200	100,0	MS17985C736 / NAS1337A2C36D	4211.E36
7/16	0,4345	0,4360	4,0	0,509	0,380	0,390	0,625	2,065	1,47	0,850	0,4425	28.500	-65	200	107,0	MS17985C740 / NAS1337A2C40D	4211.E40
7/16	0,4345	0,4360	4,2	0,509	0,380	0,390	0,625	2,065	1,47	0,850	0,4425	28.500	-65	200	111,0	MS17985C742 / NAS1337A2C42D	4211.E42
7/16	0,4345	0,4360	4,6	0,509	0,380	0,390	0,625	2,065	1,47	0,850	0,4425	28.500	-65	200	119,0	MS17985C746 / NAS1337A2C46D	4211.E46
7/16	0,4345	0,4360	5,0	0,509	0,380	0,390	0,625	2,065	1,47	0,850	0,4425	28.500	-65	200	126,0	MS17985C750 / NAS1337A2C50D	4211.E50
7/16	0,4345	0,4360	5,3	0,509	0,380	0,390	0,625	2,065	1,47	0,850	0,4425	28.500	-65	200	132,0	MS17985C753 / NAS1337A2C53D	4211.E53
7/16	0,4345	0,4360	5,5	0,509	0,380	0,390	0,625	2,065	1,47	0,850	0,4425	28.500	-65	200	135,0	MS17985C755 / NAS1337A2C55D	4211.E55
7/16	0,4345	0,4360	5,6	0,509	0,380	0,390	0,625	2,065	1,47	0,850	0,4425	28.500	-65	200	137,0	MS17985C756 / NAS1337A2C56D	4211.E56
7/16	0,4345	0,4360	5,8	0,509	0,380	0,390	0,625	2,065	1,47	0,850	0,4425	28.500	-65	200	141,0	MS17985C758 / NAS1337A2C58D	4211.E58
1/2	0,4970	0,4985	0,8	0,594	0,460	0,565	0,800	2,345	1,60	0,885	0,5050	36.900	-65	200	69,6	MS17985C808 / NAS1338A2C08D	4211.F08
1/2	0,4970	0,4985	0,9	0,594	0,460	0,565	0,800	2,345	1,60	0,885	0,5050	36.900	-65	200	72,1	MS17985C809 / NAS1338A2C09D	4211.F09
1/2	0,4970	0,4985	1,0	0,594	0,460	0,565	0,800	2,345	1,60	0,885	0,5050	36.900	-65	200	74,4	MS17985C810 / NAS1338A2C10D	4211.F10
1/2	0,4970	0,4985	1,1	0,594	0,460	0,565	0,800	2,345	1,60	0,885	0,5050	36.900	-65	200	76,9	MS17985C811 / NAS1338A2C11D	4211.F11
1/2	0,4970	0,4985	1,2	0,594	0,460	0,565	0,800	2,345	1,60	0,885	0,5050	36.900	-65	200	79,3	MS17985C812 / NAS1338A2C12D	4211.F12
1/2	0,4970	0,4985	1,3	0,594	0,460	0,565	0,800	2,345	1,60	0,885	0,5050	36.900	-65	200	81,8	MS17985C813 / NAS1338A2C13D	4211.F13

Jmenovitý průměr A	A min.	A max.	Upínací délka L +0,02 0	Rozměry						Montážní otvor max.	Pevnost ve stříhu, ve dvou průřezích min.				Standardní popis	Obj. č.	
				B ±0,005	C 0 -0,04	D max.	E max.	F max.	G max.			H min.	min.				max.
[palec]	[palec]	[palec]	[palec]	[palec]						[palec]	[lbf]	[°F]		[g]			
1/2	0,4970	0,4985	1,4	0,594	0,460	0,5650	0,800	2,345	1,60	0,885	0,5050	36.900	-65	200	84,2	MS17985C814 / NAS1338A2C14D	4211.F14
1/2	0,4970	0,4985	1,5	0,594	0,460	0,5650	0,800	2,345	1,60	0,885	0,5050	36.900	-65	200	86,6	MS17985C815 / NAS1338A2C15D	4211.F15
1/2	0,4970	0,4985	1,6	0,594	0,460	0,5650	0,800	2,345	1,60	0,885	0,5050	36.900	-65	200	89,1	MS17985C816 / NAS1338A2C16D	4211.F16
1/2	0,4970	0,4985	1,7	0,594	0,460	0,5650	0,800	2,345	1,60	0,885	0,5050	36.900	-65	200	91,5	MS17985C817 / NAS1338A2C17D	4211.F17
1/2	0,4970	0,4985	1,8	0,594	0,460	0,5650	0,800	2,345	1,60	0,885	0,5050	36.900	-65	200	94,0	MS17985C818 / NAS1338A2C18D	4211.F18
1/2	0,4970	0,4985	1,9	0,594	0,460	0,5650	0,800	2,345	1,60	0,885	0,5050	36.900	-65	200	96,4	MS17985C819 / NAS1338A2C19D	4211.F19
1/2	0,4970	0,4985	2,0	0,594	0,460	0,5650	0,800	2,345	1,60	0,885	0,5050	36.900	-65	200	98,8	MS17985C820 / NAS1338A2C20D	4211.F20
1/2	0,4970	0,4985	2,1	0,594	0,460	0,5650	0,800	2,345	1,60	0,885	0,5050	36.900	-65	200	101,0	MS17985C821 / NAS1338A2C21D	4211.F21
1/2	0,4970	0,4985	2,2	0,594	0,460	0,5650	0,800	2,345	1,60	0,885	0,5050	36.900	-65	200	104,0	MS17985C822 / NAS1338A2C22D	4211.F22
1/2	0,4970	0,4985	2,3	0,594	0,460	0,5650	0,800	2,345	1,60	0,885	0,5050	36.900	-65	200	106,0	MS17985C823 / NAS1338A2C23D	4211.F23
1/2	0,4970	0,4985	2,4	0,594	0,460	0,5650	0,800	2,345	1,60	0,885	0,5050	36.900	-65	200	109,0	MS17985C824 / NAS1338A2C24D	4211.F24
1/2	0,4970	0,4985	2,5	0,594	0,460	0,5650	0,800	2,345	1,60	0,885	0,5050	36.900	-65	200	111,0	MS17985C825 / NAS1338A2C25D	4211.F25
1/2	0,4970	0,4985	2,6	0,594	0,460	0,5650	0,800	2,345	1,60	0,885	0,5050	36.900	-65	200	114,0	MS17985C826 / NAS1338A2C26D	4211.F26
1/2	0,4970	0,4985	2,8	0,594	0,460	0,5650	0,800	2,345	1,60	0,885	0,5050	36.900	-65	200	118,0	MS17985C828 / NAS1338A2C28D	4211.F28
1/2	0,4970	0,4985	2,9	0,594	0,460	0,5650	0,800	2,345	1,60	0,885	0,5050	36.900	-65	200	121,0	MS17985C829 / NAS1338A2C29D	4211.F29
1/2	0,4970	0,4985	3,0	0,594	0,460	0,5650	0,800	2,345	1,60	0,885	0,5050	36.900	-65	200	123,0	MS17985C830 / NAS1338A2C30D	4211.F30
1/2	0,4970	0,4985	3,1	0,594	0,460	0,5650	0,800	2,345	1,60	0,885	0,5050	36.900	-65	200	126,0	MS17985C831 / NAS1338A2C31D	4211.F31
1/2	0,4970	0,4985	3,2	0,594	0,460	0,5650	0,800	2,345	1,60	0,885	0,5050	36.900	-65	200	128,0	MS17985C832 / NAS1338A2C32D	4211.F32
1/2	0,4970	0,4985	3,3	0,594	0,460	0,5650	0,800	2,345	1,60	0,885	0,5050	36.900	-65	200	138,0	MS17985C833 / NAS1338A2C33D	4211.F33
1/2	0,4970	0,4985	3,4	0,594	0,460	0,5650	0,800	2,345	1,60	0,885	0,5050	36.900	-65	200	133,0	MS17985C834 / NAS1338A2C34D	4211.F34
1/2	0,4970	0,4985	3,5	0,594	0,460	0,5650	0,800	2,345	1,60	0,885	0,5050	36.900	-65	200	135,0	MS17985C835 / NAS1338A2C35D	4211.F35
1/2	0,4970	0,4985	3,6	0,594	0,460	0,5650	0,800	2,345	1,60	0,885	0,5050	36.900	-65	200	138,0	MS17985C836 / NAS1338A2C36D	4211.F36
1/2	0,4970	0,4985	3,7	0,594	0,460	0,5650	0,800	2,345	1,60	0,885	0,5050	36.900	-65	200	140,0	MS17985C837 / NAS1338A2C37D	4211.F37
1/2	0,4970	0,4985	4,0	0,594	0,460	0,5650	0,800	2,345	1,60	0,885	0,5050	36.900	-65	200	148,0	MS17985C840 / NAS1338A2C40D	4211.F40
1/2	0,4970	0,4985	4,2	0,594	0,460	0,5650	0,800	2,345	1,60	0,885	0,5050	36.900	-65	200	153,0	MS17985C842 / NAS1338A2C42D	4211.F42
1/2	0,4970	0,4985	4,3	0,594	0,460	0,5650	0,800	2,345	1,60	0,885	0,5050	36.900	-65	200	155,0	MS17985C843 / NAS1338A2C43D	4211.F43
1/2	0,4970	0,4985	4,4	0,594	0,460	0,5650	0,800	2,345	1,60	0,885	0,5050	36.900	-65	200	157,0	MS17985C844 / NAS1338A2C44D	4211.F44
1/2	0,4970	0,4985	4,5	0,594	0,460	0,5650	0,800	2,345	1,60	0,885	0,5050	36.900	-65	200	160,0	MS17985C845 / NAS1338A2C45D	4211.F45
1/2	0,4970	0,4985	4,6	0,594	0,460	0,5650	0,800	2,345	1,60	0,885	0,5050	36.900	-65	200	162,0	MS17985C846 / NAS1338A2C46D	4211.F46
1/2	0,4970	0,4985	4,7	0,594	0,460	0,5650	0,800	2,345	1,60	0,885	0,5050	36.900	-65	200	165,0	MS17985C847 / NAS1338A2C47D	4211.F47
1/2	0,4970	0,4985	4,8	0,594	0,460	0,5650	0,800	2,345	1,60	0,885	0,5050	36.900	-65	200	167,0	MS17985C848 / NAS1338A2C48D	4211.F48
1/2	0,4970	0,4985	5,0	0,594	0,460	0,5650	0,800	2,345	1,60	0,885	0,5050	36.900	-65	200	172,0	MS17985C850 / NAS1338A2C50D	4211.F50

Jmenovitý průměr A	A min.	A max.	Upínací délka L +0,02 0	Rozměry						Montážní otvor max.	Pevnost ve stříhu, ve dvou průřezích min.	 min. max.		 [g]	Standardní popis	Obj. č.	
	[palec]	[palec]		[palec]	B ±0,005	C 0 -0,04	D max.	E max.	F max.			G max.	H min.				[palec]
1/2	0,4970	0,4985	5,5	0,594	0,460	0,565	0,800	2,345	1,60	0,885	0,5050	36.900	-65	200	184,0	MS17985C855 / NAS1338A2C55D	4211.F55
1/2	0,4970	0,4985	6,0	0,594	0,460	0,565	0,800	2,345	1,60	0,885	0,5050	36.900	-65	200	196,0	MS17985C860 / NAS1338A2C60D	4211.F60
9/16	0,5595	0,5610	1,0	0,666	0,510	0,565	0,800	2,345	1,60	0,885	0,5675	46.700	-65	200	84,9	MS17985C910 / NAS1339A2C10D	4211.G10
9/16	0,5595	0,5610	1,2	0,666	0,510	0,565	0,800	2,345	1,60	0,885	0,5675	46.700	-65	200	91,2	MS17985C912 / NAS1339A2C12D	4211.G12
9/16	0,5595	0,5610	1,7	0,666	0,510	0,565	0,800	2,345	1,60	0,885	0,5675	46.700	-65	200	107,0	MS17985C917 / NAS1339A2C17D	4211.G17
9/16	0,5595	0,5610	2,4	0,666	0,510	0,565	0,800	2,345	1,60	0,885	0,5675	46.700	-65	200	128,0	MS17985C924 / NAS1339A2C24D	4211.G24
9/16	0,5595	0,5610	2,5	0,666	0,510	0,565	0,800	2,345	1,60	0,885	0,5675	46.700	-65	200	132,0	MS17985C925 / NAS1339A2C25D	4211.G25
9/16	0,5595	0,5610	3,2	0,666	0,510	0,565	0,800	2,345	1,60	0,885	0,5675	46.700	-65	200	153,0	MS17985C932 / NAS1339A2C32D	4211.G32
9/16	0,5595	0,5610	3,6	0,666	0,510	0,565	0,800	2,345	1,60	0,885	0,5675	46.700	-65	200	166,0	MS17985C936 / NAS1339A2C36D	4211.G36
9/16	0,5595	0,5610	4,0	0,666	0,510	0,565	0,800	2,345	1,60	0,885	0,5675	46.700	-65	200	178,0	MS17985C940 / NAS1339A2C40D	4211.G40
9/16	0,5595	0,5610	5,0	0,666	0,510	0,565	0,800	2,345	1,60	0,885	0,5675	46.700	-65	200	209,0	MS17985C950 / NAS1339A2C50D	4211.G50
9/16	0,5595	0,5610	5,5	0,666	0,510	0,565	0,800	2,345	1,60	0,885	0,5675	46.700	-65	200	225,0	MS17985C955 / NAS1339A2C55D	4211.G55
5/8	0,6220	0,6240	1,4	0,750	0,580	0,580	0,975	3,100	1,70	0,980	0,6300	57.800	-65	200	147,0	MS17985C1014 / NAS1340A2C14D	4211.H14
5/8	0,6220	0,6240	1,5	0,750	0,580	0,580	0,975	3,100	1,70	0,980	0,6300	57.800	-65	200	151,0	MS17985C1015 / NAS1340A2C15D	4211.H15
5/8	0,6220	0,6240	1,6	0,750	0,580	0,580	0,975	3,100	1,70	0,980	0,6300	57.800	-65	200	155,0	MS17985C1016 / NAS1340A2C16D	4211.H16
5/8	0,6220	0,6240	1,8	0,750	0,580	0,580	0,975	3,100	1,70	0,980	0,6300	57.800	-65	200	162,0	MS17985C1018 / NAS1340A2C18D	4211.H18
5/8	0,6220	0,6240	2,0	0,750	0,580	0,580	0,975	3,100	1,70	0,980	0,6300	57.800	-65	200	170,0	MS17985C1020 / NAS1340A2C20D	4211.H20
5/8	0,6220	0,6240	2,5	0,750	0,580	0,580	0,975	3,100	1,70	0,980	0,6300	57.800	-65	200	190,0	MS17985C1025 / NAS1340A2C25D	4211.H25
5/8	0,6220	0,6240	2,6	0,750	0,580	0,580	0,975	3,100	1,70	0,980	0,6300	57.800	-65	200	193,0	MS17985C1026 / NAS1340A2C26D	4211.H26
5/8	0,6220	0,6240	3,0	0,750	0,580	0,580	0,975	3,100	1,70	0,980	0,6300	57.800	-65	200	209,0	MS17985C1030 / NAS1340A2C30D	4211.H30
5/8	0,6220	0,6240	3,2	0,750	0,580	0,580	0,975	3,100	1,70	0,980	0,6300	57.800	-65	200	216,0	MS17985C1032 / NAS1340A2C32D	4211.H32
5/8	0,6220	0,6240	3,5	0,750	0,580	0,580	0,975	3,100	1,70	0,980	0,6300	57.800	-65	200	228,0	MS17985C1035 / NAS1340A2C35D	4211.H35
5/8	0,6220	0,6240	3,8	0,750	0,580	0,580	0,975	3,100	1,70	0,980	0,6300	57.800	-65	200	239,0	MS17985C1038 / NAS1340A2C38D	4211.H38
5/8	0,6220	0,6240	4,0	0,750	0,580	0,580	0,975	3,100	1,70	0,980	0,6300	57.800	-65	200	247,0	MS17985C1040 / NAS1340A2C40D	4211.H40
5/8	0,6220	0,6240	4,5	0,750	0,580	0,580	0,975	3,100	1,70	0,980	0,6300	57.800	-65	200	267,0	MS17985C1045 / NAS1340A2C45D	4211.H45
5/8	0,6220	0,6240	6,0	0,750	0,580	0,580	0,975	3,100	1,70	0,980	0,6300	57.800	-65	200	324,0	MS17985C1060 / NAS1340A2C60D	4211.H60
3/4	0,7470	0,7485	1,6	0,887	0,670	0,700	1,000	3,100	1,72	1,030	0,7570	83.200	-65	200	198,0	MS17985C1216 / NAS1341A2C16D	4211.K16
3/4	0,7470	0,7485	2,5	0,887	0,670	0,700	1,000	3,100	1,72	1,030	0,7570	83.200	-65	200	248,0	MS17985C1225 / NAS1341A2C25D	4211.K25
3/4	0,7470	0,7485	3,0	0,887	0,670	0,700	1,000	3,100	1,72	1,030	0,7570	83.200	-65	200	276,0	MS17985C1230 / NAS1341A2C30D	4211.K30
3/4	0,7470	0,7485	3,1	0,887	0,670	0,700	1,000	3,100	1,72	1,030	0,7570	83.200	-65	200	281,0	MS17985C1231 / NAS1341A2C31D	4211.K31
3/4	0,7470	0,7485	4,0	0,887	0,670	0,700	1,000	3,100	1,72	1,030	0,7570	83.200	-65	200	331,0	MS17985C1240 / NAS1341A2C40D	4211.K40
3/4	0,7470	0,7485	4,2	0,887	0,670	0,700	1,000	3,100	1,72	1,030	0,7570	83.200	-65	200	342,0	MS17985C1242 / NAS1341A2C42D	4211.K42



Jmenovitý průměr A	A min.	A max.	Upínací délka L +0,02 0	Rozměry							Montážní otvor max.	Pevnost ve stříhu, ve dvou průřezích min.	 min. max.		 [g]	Standardní popis	Obj. č.
				B ±0,005	C 0 -0,04	D max.	E max.	F max.	G max.	H min.			[palec]	[°F]			
[palec]	[palec]	[palec]	[palec]	[palec]							[palec]	[lbf]	[°F]		[g]		
3/4	0,7470	0,7485	5,0	0,887	0,670	0,700	1,000	3,100	1,72	1,030	0,7570	83.200	-65	200	387,0	MS17985C1250 / NAS1341A2C50D	4211.K50
3/4	0,7470	0,7485	5,0	0,887	0,670	0,700	1,000	3,100	1,72	1,030	0,7570	83.200	-65	200	392,0	MS17985C1251 / NAS1341A2C51D	4211.K51
7/8	0,8720	0,8735	4,0	1,046	0,760	0,840	1,320	3,520	2,17	1,310	0,8820	112.500	-65	200	506,0	MS17985C1440 / NAS1342A2C40D	4211.L40
1	0,9970	0,9985	1,0	1,219	0,810	0,950	1,320	3,520	2,17	1,310	1,0100	147.200	-65	200	333,0	MS17985C1610 / NAS1343A2C10D	4211.M10
1	0,9970	0,9985	1,5	1,219	0,810	0,950	1,320	3,520	2,17	1,310	1,0100	147.200	-65	200	383,0	MS17985C1615 / NAS1343A2C15D	4211.M15
1	0,9970	0,9985	2,9	1,219	0,810	0,950	1,320	3,520	2,17	1,310	1,0100	147.200	-65	200	522,0	MS17985C1629 / NAS1343A2C29D	4211.M29
1	0,9970	0,9985	3,1	1,219	0,810	0,950	1,320	3,520	2,17	1,310	1,0100	147.200	-65	200	541,0	MS17985C1631 / NAS1343A2C31D	4211.M31
1	0,9970	0,9985	3,3	1,219	0,810	0,950	1,320	3,520	2,17	1,310	1,0100	147.200	-65	200	561,0	MS17985C1633 / NAS1343A2C33D	4211.M33
1	0,9970	0,9985	4,0	1,219	0,810	0,950	1,320	3,520	2,17	1,310	1,0100	147.200	-65	200	631,0	MS17985C1640 / NAS1343A2C40D	4211.M40
1	0,9970	0,9985	5,0	1,219	0,810	0,950	1,320	3,520	2,17	1,310	1,0100	147.200	-65	200	581,0	MS17985C1650 / NAS1343A2C50D	4211.M50
1	0,9970	0,9985	5,5	1,219	0,810	0,950	1,320	3,520	2,17	1,310	1,0100	147.200	-65	200	779,0	MS17985C1655 / NAS1343A2C55D	4211.M55

## Shoda

### Vyhovuje RoHS

V souladu se směrnicí 2011/65/EU a směrnicí 2015/863.

### Neobsahuje látky SVHC

Žádné látky SVHC s obsahem vyšším než 0,1% hm. - seznam SVHC k 27.06.2024.

### Neobsahuje látky Proposition 65

Neobsahuje látky Proposition 65.  
<https://www.P65Warnings.ca.gov/>

### Bez konfliktních minerálů

Tento produkt neobsahuje žádné látky označené jako "konfliktní minerály" jako je tantal, cín, zlato nebo wolfram z Demokratické republiky Kongo nebo sousedních zemí.