

## Čepy s kuličkami • samojistné, s elastickým držadlem

EH 22370. /EH 22380.



### Popis produktu

K časté fixaci, aretaci, přestavění, výměně a zajištění dílů. Pro mnohostranné použití v různých odvětvích, např. sport, volný čas, medicína, strojírenství atd. Rychlá a jednoduchá možnost uvolnění pro často se opakující spojení.

Všechna provedení jsou korozivzdorná. U nerez 1.4542 je vysoce pevný čep, tvrzený, extrémně zatížitelný, vysoce odolný proti opotřebení.

Elastické, ergonomické držadlo se samostatným vrácením do původní polohy (zajištění). Nový, moderní, patentovaný design.

### Materiál

#### Čepová část

- Nerez 1.4305
- Nerez 1.4542, tvrzená

#### Držadlo

- Termoplast (PBT/TPE), šedá / oranžová

### Obsluha

Stlačením tlačítka se kuličky odblokují.

### Značení

Provedení nerez 1.4542 se značením pod kuličkami.

### Další informace

#### Poznámky

Nestandardní provedení dle požadavku.

#### Příslušenství

Možnost upevnění lanka EH 22400.

#### Další produkty

- Pouzdra, pro čep s kuličkami samojistný a čep s odpruženými kuličkami
- Pouzdra, s přírubou, pro čep s kuličkami samojistný a čep s odpruženými kuličkami
- Lanka
- Naváděcí pouzdra, s prstencem, DIN 172 A
- Naváděcí pouzdra, bez prstence, DIN 179 A

### Výkres s rozměry





\*\* Provedení nerez 1.4542 se značením.



### Informace pro objednání

d <sub>1</sub>		l <sub>1</sub>	d <sub>2</sub>	d <sub>3</sub>	d <sub>4</sub>	l <sub>2</sub>	l <sub>3</sub>	l <sub>4</sub>	Montážní otvor H11	min.	max.		Pevnost ve stříhu, ve dvou průřezích <sup>1)</sup> min.	Obj. č.
-0,04 -0,08		+0,6				±1			[mm]	[mm]	[°C]	[g]	[kN]	
<b>Nerez 1.4305</b>														
5	10	5,5	36	12,7	6,0	31,0	15,9	5	-30	80	9,2	14	22370.0712	
5	15	5,5	36	12,7	6,0	31,0	15,9	5	-30	80	9,9	14	22370.0713	
5	20	5,5	36	12,7	6,0	31,0	15,9	5	-30	80	11,0	14	22370.0714	
5	25	5,5	36	12,7	6,0	31,0	15,9	5	-30	80	11,0	14	22370.0715	
5	30	5,5	36	12,7	6,0	31,0	15,9	5	-30	80	12,0	14	22370.0716	

<sup>1)</sup> Pevnost ve stříhu odpovídající DIN 50141

d <sub>1</sub> -0,04 -0,08	l <sub>1</sub> +0,6	Rozměry						Montážní otvor H11	 min.   max.		 [g]	Pevnost ve stříhu, ve dvou průřezech <sup>1)</sup> min. [kN]	Obj. č.
		d <sub>2</sub>	d <sub>3</sub>	d <sub>4</sub>	l <sub>2</sub> ±1	l <sub>3</sub>	l <sub>4</sub>		[mm]	[°C]			
6	10	7,0	36	12,7	7,0	31,0	15,9	6	-30	80	10,0	21	22370.0722
6	15	7,0	36	12,7	7,0	31,0	15,9	6	-30	80	11,0	21	22370.0723
6	20	7,0	36	12,7	7,0	31,0	15,9	6	-30	80	12,0	21	22370.0724
6	25	7,0	36	12,7	7,0	31,0	15,9	6	-30	80	13,0	21	22370.0725
6	30	7,0	36	12,7	7,0	31,0	15,9	6	-30	80	14,0	21	22370.0726
6	35	7,0	36	12,7	7,0	31,0	15,9	6	-30	80	15,0	21	22370.0727
6	40	7,0	36	12,7	7,0	31,0	15,9	6	-30	80	16,0	21	22370.0728
6	45	7,0	36	12,7	7,0	31,0	15,9	6	-30	80	17,0	21	22370.0729
6	50	7,0	36	12,7	7,0	31,0	15,9	6	-30	80	18,0	21	22370.0730
8	20	9,5	41	16,4	8,2	34,8	19,2	8	-30	80	23,0	38	22370.0734
8	25	9,5	41	16,4	8,2	34,8	19,2	8	-30	80	24,0	38	22370.0735
8	30	9,5	41	16,4	8,2	34,8	19,2	8	-30	80	26,0	38	22370.0736
8	35	9,5	41	16,4	8,2	34,8	19,2	8	-30	80	28,0	38	22370.0737
8	40	9,5	41	16,4	8,2	34,8	19,2	8	-30	80	30,0	38	22370.0738
8	45	9,5	41	16,4	8,2	34,8	19,2	8	-30	80	32,0	38	22370.0739
8	50	9,5	41	16,4	8,2	34,8	19,2	8	-30	80	34,0	38	22370.0740
10	20	12,0	41	16,4	9,6	34,8	19,2	10	-30	80	30,0	60	22370.0744
10	25	12,0	41	16,4	9,6	34,8	19,2	10	-30	80	32,0	60	22370.0745
10	30	12,0	41	16,4	9,6	34,8	19,2	10	-30	80	35,0	60	22370.0746
10	35	12,0	41	16,4	9,6	34,8	19,2	10	-30	80	38,0	60	22370.0747
10	40	12,0	41	16,4	9,6	34,8	19,2	10	-30	80	41,0	60	22370.0748
10	45	12,0	41	16,4	9,6	34,8	19,2	10	-30	80	44,0	60	22370.0749
10	50	12,0	41	16,4	9,6	34,8	19,2	10	-30	80	47,0	60	22370.0750
10	60	12,0	41	16,4	9,6	34,8	19,2	10	-30	80	53,0	60	22370.0752
12	25	14,5	49	21,2	10,6	40,5	24,8	12	-30	80	54,0	87	22370.0765
12	30	14,5	49	21,2	10,6	40,5	24,8	12	-30	80	58,0	87	22370.0766
12	35	14,5	49	21,2	10,6	40,5	24,8	12	-30	80	63,0	87	22370.0767
12	40	14,5	49	21,2	10,6	40,5	24,8	12	-30	80	67,0	87	22370.0768
12	45	14,5	49	21,2	10,6	40,5	24,8	12	-30	80	71,0	87	22370.0769
12	50	14,5	49	21,2	10,6	40,5	24,8	12	-30	80	75,0	87	22370.0770
12	60	14,5	49	21,2	10,6	40,5	24,8	12	-30	80	83,0	87	22370.0772
12	70	14,5	49	21,2	10,6	40,5	24,8	12	-30	80	111,0	87	22370.0774
12	80	14,5	49	21,2	10,6	40,5	24,8	12	-30	80	101,0	87	22370.0776
16	30	19,0	49	21,2	14,0	40,5	24,8	16	-30	80	92,0	155	22370.0786
16	35	19,0	49	21,2	14,0	40,5	24,8	16	-30	80	98,0	155	22370.0787
16	40	19,0	49	21,2	14,0	40,5	24,8	16	-30	80	109,0	155	22370.0788
16	45	19,0	49	21,2	14,0	40,5	24,8	16	-30	80	114,0	155	22370.0789
16	50	19,0	49	21,2	14,0	40,5	24,8	16	-30	80	125,0	155	22370.0790
16	60	19,0	49	21,2	14,0	40,5	24,8	16	-30	80	139,0	155	22370.0792
16	70	19,0	49	21,2	14,0	40,5	24,8	16	-30	80	156,0	155	22370.0794
16	80	19,0	49	21,2	14,0	40,5	24,8	16	-30	80	171,0	155	22370.0796
<b>Nerez 1.4542, tvrzená</b>													
5	10	5,5	36	12,7	6,0	31,0	15,9	5	-30	80	9,2	24	22380.0712
5	15	5,5	36	12,7	6,0	31,0	15,9	5	-30	80	9,9	24	22380.0713
5	20	5,5	36	12,7	6,0	31,0	15,9	5	-30	80	11,0	24	22380.0714
5	25	5,5	36	12,7	6,0	31,0	15,9	5	-30	80	11,0	24	22380.0715
5	30	5,5	36	12,7	6,0	31,0	15,9	5	-30	80	12,0	24	22380.0716
6	10	7,0	36	12,7	7,0	31,0	15,9	6	-30	80	10,0	35	22380.0722
6	15	7,0	36	12,7	7,0	31,0	15,9	6	-30	80	11,0	35	22380.0723
6	20	7,0	36	12,7	7,0	31,0	15,9	6	-30	80	12,0	35	22380.0724
6	25	7,0	36	12,7	7,0	31,0	15,9	6	-30	80	13,0	35	22380.0725
6	30	7,0	36	12,7	7,0	31,0	15,9	6	-30	80	14,0	35	22380.0726
6	35	7,0	36	12,7	7,0	31,0	15,9	6	-30	80	15,0	35	22380.0727
6	40	7,0	36	12,7	7,0	31,0	15,9	6	-30	80	16,0	35	22380.0728
6	45	7,0	36	12,7	7,0	31,0	15,9	6	-30	80	17,0	35	22380.0729
6	50	7,0	36	12,7	7,0	31,0	15,9	6	-30	80	18,0	35	22380.0730
8	20	9,5	41	16,4	8,2	34,8	19,2	8	-30	80	23,0	63	22380.0734
8	25	9,5	41	16,4	8,2	34,8	19,2	8	-30	80	24,0	63	22380.0735

<sup>1)</sup> Pevnost ve stříhu odpovídající DIN 50141

d <sub>1</sub> -0,04 -0,08	l <sub>1</sub> +0,6	Rozměry						Montážní otvor H11 [mm]	 min.   max. [°C]		 [g]	Pevnost ve stříhu, ve dvou průřezích <sup>1)</sup> min. [kN]	Obj. č.
		d <sub>2</sub>	d <sub>3</sub>	d <sub>4</sub>	l <sub>2</sub> ±1	l <sub>3</sub>	l <sub>4</sub>						
8	30	9,5	41	16,4	8,2	34,8	19,2	8	-30	80	26,0	63	22380.0736
8	35	9,5	41	16,4	8,2	34,8	19,2	8	-30	80	28,0	63	22380.0737
8	40	9,5	41	16,4	8,2	34,8	19,2	8	-30	80	30,0	63	22380.0738
8	45	9,5	41	16,4	8,2	34,8	19,2	8	-30	80	32,0	63	22380.0739
8	50	9,5	41	16,4	8,2	34,8	19,2	8	-30	80	34,0	63	22380.0740
10	20	12,0	41	16,4	9,6	34,8	19,2	10	-30	80	30,0	100	22380.0744
10	25	12,0	41	16,4	9,6	34,8	19,2	10	-30	80	32,0	100	22380.0745
10	30	12,0	41	16,4	9,6	34,8	19,2	10	-30	80	35,0	100	22380.0746
10	35	12,0	41	16,4	9,6	34,8	19,2	10	-30	80	38,0	100	22380.0747
10	40	12,0	41	16,4	9,6	34,8	19,2	10	-30	80	41,0	100	22380.0748
10	45	12,0	41	16,4	9,6	34,8	19,2	10	-30	80	44,0	100	22380.0749
10	50	12,0	41	16,4	9,6	34,8	19,2	10	-30	80	47,0	100	22380.0750
10	60	12,0	41	16,4	9,6	34,8	19,2	10	-30	80	53,0	100	22380.0752
12	25	14,5	49	21,2	10,6	40,5	24,8	12	-30	80	54,0	144	22380.0765
12	30	14,5	49	21,2	10,6	40,5	24,8	12	-30	80	58,0	144	22380.0766
12	35	14,5	49	21,2	10,6	40,5	24,8	12	-30	80	63,0	144	22380.0767
12	40	14,5	49	21,2	10,6	40,5	24,8	12	-30	80	67,0	144	22380.0768
12	45	14,5	49	21,2	10,6	40,5	24,8	12	-30	80	71,0	144	22380.0769
12	50	14,5	49	21,2	10,6	40,5	24,8	12	-30	80	75,0	144	22380.0770
12	60	14,5	49	21,2	10,6	40,5	24,8	12	-30	80	83,0	144	22380.0772
12	70	14,5	49	21,2	10,6	40,5	24,8	12	-30	80	111,0	144	22380.0774
12	80	14,5	49	21,2	10,6	40,5	24,8	12	-30	80	101,0	144	22380.0776
16	30	19,0	49	21,2	14,0	40,5	24,8	16	-30	80	92,0	257	22380.0786
16	35	19,0	49	21,2	14,0	40,5	24,8	16	-30	80	98,0	257	22380.0787
16	40	19,0	49	21,2	14,0	40,5	24,8	16	-30	80	109,0	257	22380.0788
16	45	19,0	49	21,2	14,0	40,5	24,8	16	-30	80	114,0	257	22380.0789
16	50	19,0	49	21,2	14,0	40,5	24,8	16	-30	80	125,0	257	22380.0790
16	60	19,0	49	21,2	14,0	40,5	24,8	16	-30	80	139,0	257	22380.0792
16	70	19,0	49	21,2	14,0	40,5	24,8	16	-30	80	156,0	257	22380.0794
16	80	19,0	49	21,2	14,0	40,5	24,8	16	-30	80	171,0	257	22380.0796

<sup>1)</sup> Pevnost ve stříhu odpovídající DIN 50141

Příklad použití

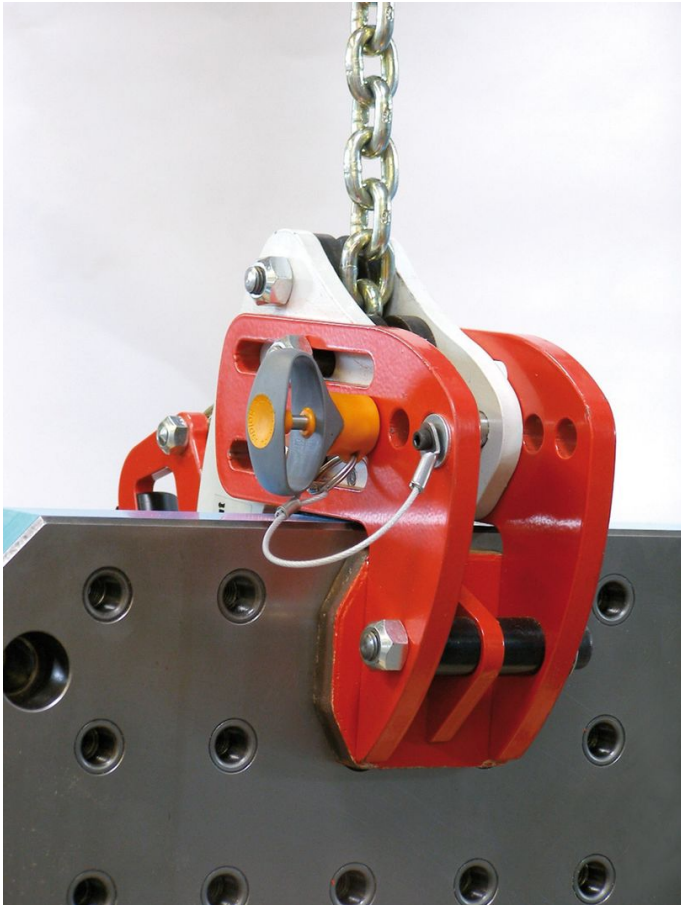
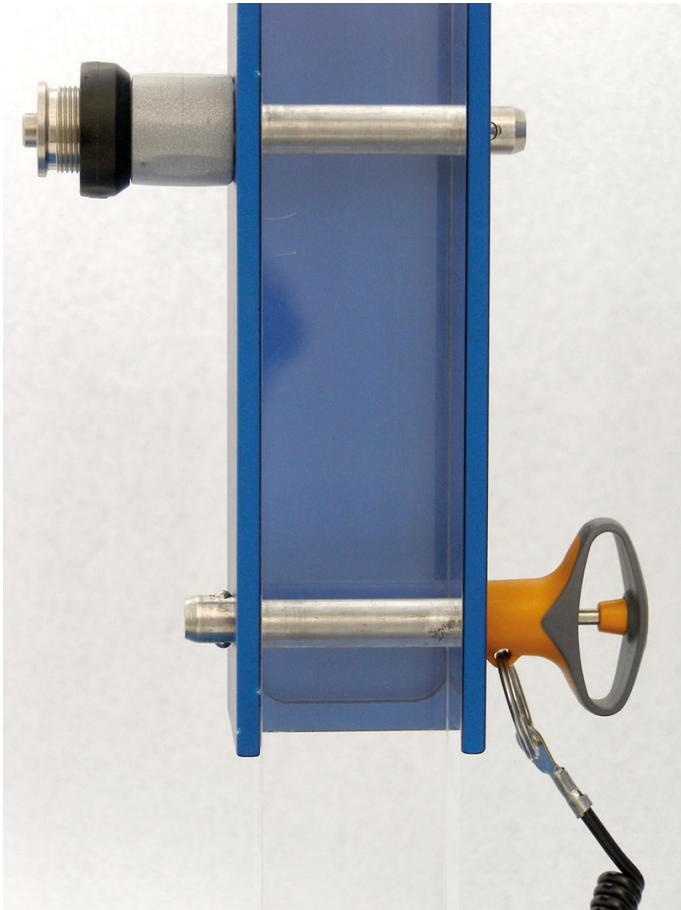

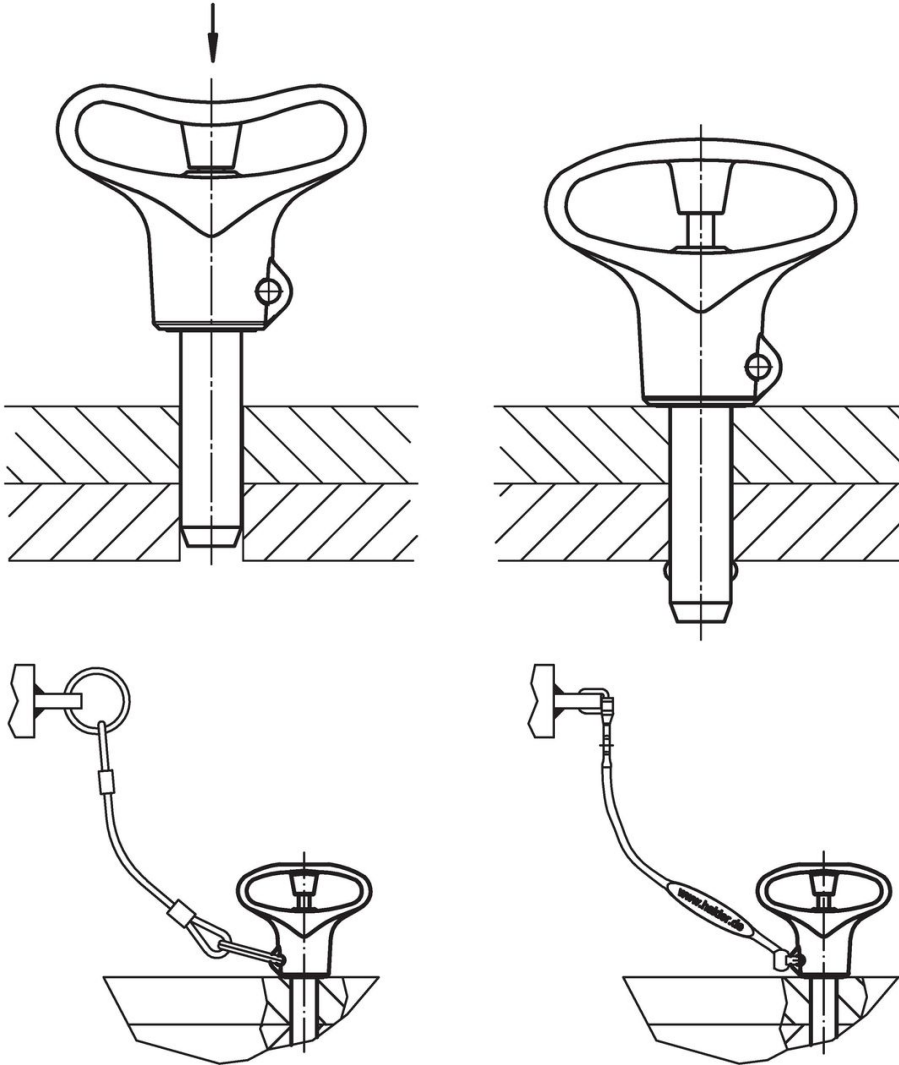

## Shoda

### Vyhovuje RoHS

V souladu se směrnicí 2011/65/EU a směrnicí 2015/863.

### Neobsahuje látky SVHC

Žádné látky SVHC s obsahem vyšším než 0,1% hm. - seznam SVHC k 27.06.2024.

### Neobsahuje látky Proposition 65

Neobsahuje látky Proposition 65.  
<https://www.P65Warnings.ca.gov/>

### Bez konfliktních minerálů

Tento produkt neobsahuje žádné látky označené jako "konfliktní minerály" jako je tantal, cín, zlato nebo wolfram z Demokratické republiky Kongo nebo sousedních zemí.