

绞链

25165.0240



产品描述

The different versions cover many applications that require a low load.

These metal hinges are characterised by their simple design and the different versions:

- without bores
- with bores
- with bores for countersunk screws

The version without bores can be assembled by welding or by inserting a specific drilling pattern.

材质

本体

- 不锈钢 1.4301

轴

- 不锈钢 1.4301

图面

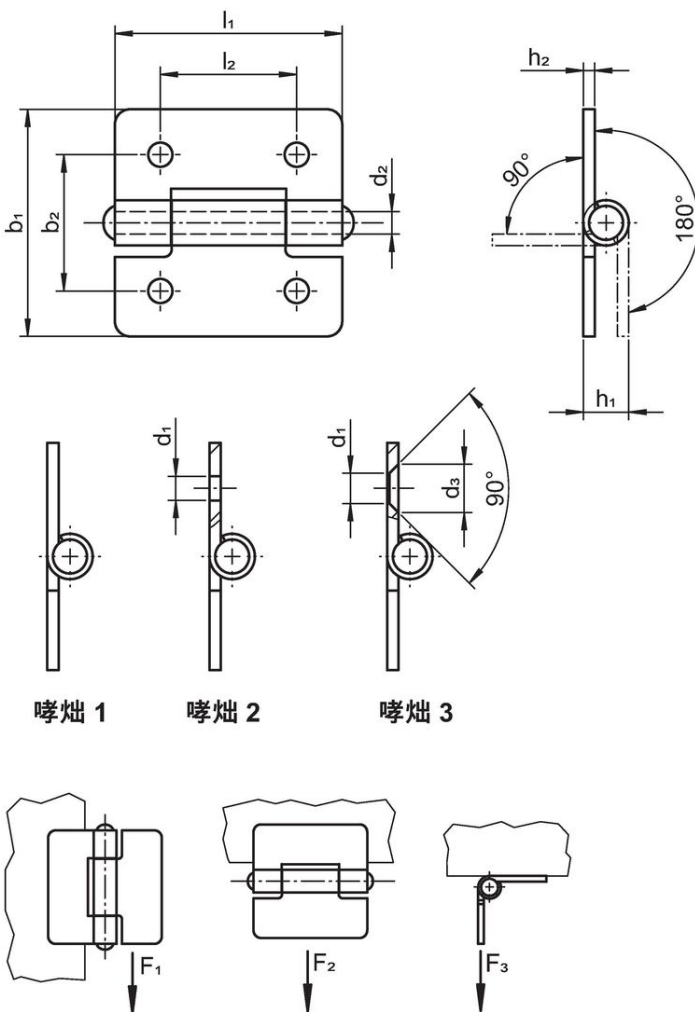

订单信息

b ₁	l ₁	b ₂	d ₁	尺寸					F ₁	夹持力			品号
				d ₂	d ₃	h ₁	h ₂	l ₂		F ₂	F ₃	[g]	
with bores for countersunk screws – 相片 3, 不锈钢													
50	50	30	4	6	8,3	10	2	30	2500	2000	1000	61	25165.0240

遵守

符合 RoHS

符合指令 2011/65/EU 和指令 2015/863

不含 SVHC 物质

不含超过 0.1% w/w 的 SVHC 物质 - 截至 2024 年 6 月 27 日的 SVHC 清单.

不含 65 号提案物质

不包括 65 号提案物质

<https://www.P65Warnings.ca.gov/>

不含冲突矿物

„本产品不含来自刚果民主共和国或邻近国家的任何被指定为“冲突矿物”的物质，例如钽、锡、金或钨。