

平压花螺帽 · DIN 467

24760.0440



产品描述

Knurled nuts are very versatile. Three material versions for the different requirements

- Steel, blackened
- Steel, zinc-plated by galvanization
- Stainless steel

are available.

Knurled nuts can be easily tightened and released by hand. The ribbed outer surface of the nut prevents slipping when tightening / releasing with the fingers.

The flat knurled nuts are manufactured according to DIN 467.

材质

- Steel, zinc-plated by galvanization, quality 5

更多信息

注意事项

根据 DIN 规范，压花的间距和深度也不同。

更多产品

- 高压花的螺母 (有轴环), DIN 466

图面

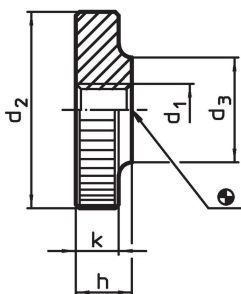

订单信息

d ₁	d ₂	尺寸 d ₃ [mm]	h	k	 [g]	品号	
钢	M4	16	8	4	3,5	5	24760.0440

应用范例

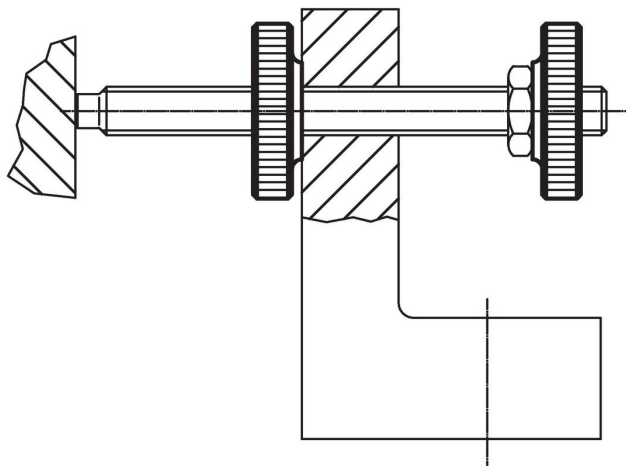

遵守

符合 RoHS

符合指令 2011/65/EU 和指令 2015/863

不含 SVHC 物质

不含超过 0.1% w/w 的 SVHC 物质 - 截至 2024 年 6 月 27 日的 SVHC 清单。

不含 65 号提案物质

不包括 65 号提案物质

<https://www.P65Warnings.ca.gov/>

不含冲突矿物

本产品不含来自刚果民主共和国或邻近国家的任何被指定为“冲突矿物”的物质，例如钽、锡、金或钨。