

星形把手螺丝 · similar to DIN 6336, stainless steel A4 24741.0115



产品描述

These star grip screws are manufactured according to DIN 6336, but it is a version without dirty edges. This makes these star grip screws suitable for all areas of application with high hygienic requirements.
The stainless steel A4 version ensures maximum corrosion resistance.

材质

把手

- Stainless steel 1.4408, precision casting, polished

螺丝

- 不锈钢 A4, 热处理

图面

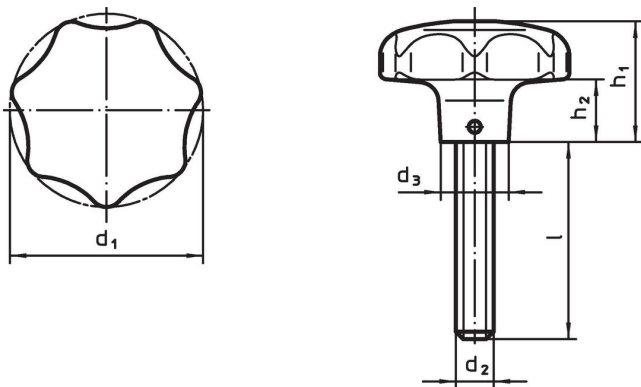

订单信息

d ₁	d ₂	尺寸 l	d ₃	h ₁	h ₂	 [g]	品号
[mm]							
40	M8	30	14	25	12	120	24741.0115

遵守

符合 RoHS

符合指令 2011/65/EU 和指令 2015/863

不含 SVHC 物质

不含超过 0.1% w/w 的 SVHC 物质 - 截至 2024 年 1 月 23 日的 SVHC 清单。

不含 65 号提案物质

不包括 65 号提案物质

<https://www.P65Warnings.ca.gov/>

不含冲突矿物

„本产品不含来自刚果民主共和国或邻近国家的任何被指定为“冲突矿物”的物质，例如钽、锡、金或钨。