

## 挖地螺丝和掌形把手 · similar to DIN 6335, stainless steel A4 24731.0155



### 产品描述

These grub screws with palm grip are manufactured according to DIN 6335, but it is a version without dirty edges. This makes these grub screws with palm grip suitable for all areas of application with high hygienic requirements. The stainless steel A4 version ensures maximum corrosion resistance.

### 材质

#### 把手

- Stainless steel A4, polished

#### 螺丝

- 不锈钢 A4, 热处理

### 图面

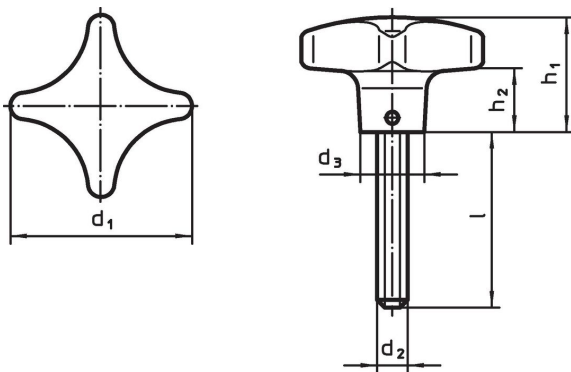

### 订单信息

d <sub>1</sub>	d <sub>2</sub>	尺寸 l [mm]	d <sub>3</sub>	h <sub>1</sub>	h <sub>2</sub>	 [g]	品号
63	M12	40	20	40	23	256	24731.0155

### 遵守

#### 符合 RoHS

符合指令 2011/65/EU 和指令 2015/863

#### 不含 SVHC 物质

不含超过 0.1% w/w 的 SVHC 物质 - 截至 2024 年 6 月 27 日的 SVHC 清单。

#### 不含 65 号提案物质

不包括 65 号提案物质

<https://www.P65Warnings.ca.gov/>

#### 不含冲突矿物

„本产品不含来自刚果民主共和国或邻近国家的任何被指定为“冲突矿物”的物质，例如钽、锡、金或钨。