

Threaded Lock Pins · 自行锁固

22355.0206



产品描述

Threaded lock pins are used for quick fastening, locking, adjusting, changing, clamping, connecting and securing. Quickly and easily unlockable for frequently repeated connections. By pressing the button, the threaded segments unlock and the threaded lock pin can be inserted into or removed from a threaded hole. A time-consuming screwing in and out is unnecessary. The threaded lock pin is characterised by the following features:

- Corrosion-protected
- No time-consuming screwing in and out
- Self-locking due to spring load

材质

梢子零件

- Steel, manganese-phosphated

把手

- Thermoplastic PA 6, black, dull similar to RAL 9005

按钮

- 铝, 橘色, 阳极

螺纹元件

- 不锈钢 1.4542、沉淀硬化

弹簧

- 不锈钢

组装

Threaded lock pins can only be mounted into a thread that is true to gauge.

Mounting:

1. Press in the button and hold it down.
2. Insert the threaded lock pin.
3. Release the button (The button must be back in its original position.).
4. Tighten the threaded lock pin by hand as required.
5. It must be ensured that the threaded segments are engaged in the mounting thread.

Dismantling:

1. Unscrew the threaded lock pin approx. a quarter of a turn anticlockwise.
2. Press in the button and hold it down.
3. Remove the threaded lock pin.
4. Release the button.

操作

The threaded segments are unlocked by pressing the button.

更多信息

注意事项

特殊的样式欢迎咨询。
Due to the thread geometry, the clamping force is higher with the smaller thread sizes.

配件

Can easily be fitted with retaining cable EH 22355.

更多产品

- Threaded Lock Pins, self-locking, with axial bearing
- 保持缆, for threaded lock pin

图面

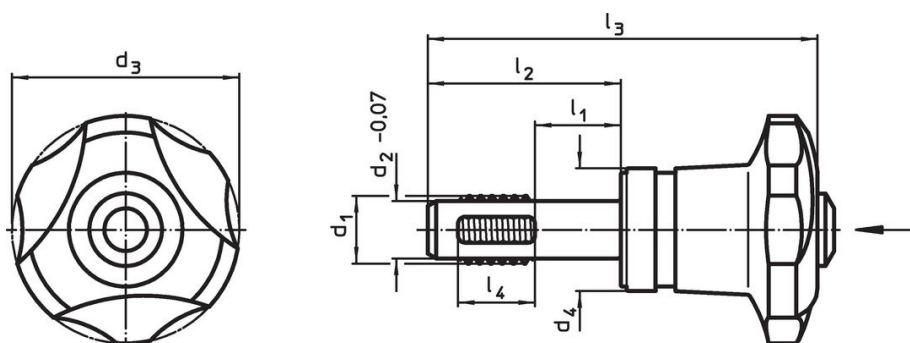

订单信息

尺寸				定位螺牙				温度		启动 扭力 max.	夹持 力量 max.	锁固力 矩的结果 ~ ¹⁾	夹持 力量 ~ ²⁾	重量	剪力抵 抗力, - 加倍的 ³⁾ min	品号	
d ₁	l ₁	d ₂ -0,07	d ₃ -1	d ₄	l ₂	l ₃	l ₄	min	max.	[Nm]	[kN]	[Nm]	[kN]	[g]	[kN]		
[mm]				[mm]				[°C]									
Steel, manganese-phosphated																	
M10	30	8,35	40	21,6	46	80,6	10	M10	-30	80	5	2,9	3,5	2	99	20,6	22355.0206

¹⁾ 經試驗得知的平均握力。

²⁾ 經試驗得知的平均值。

³⁾ 剪切強度與DIN 50141相似；此評估適用於接合的使用狀態（無受扭轉妨礙）。

应用范例

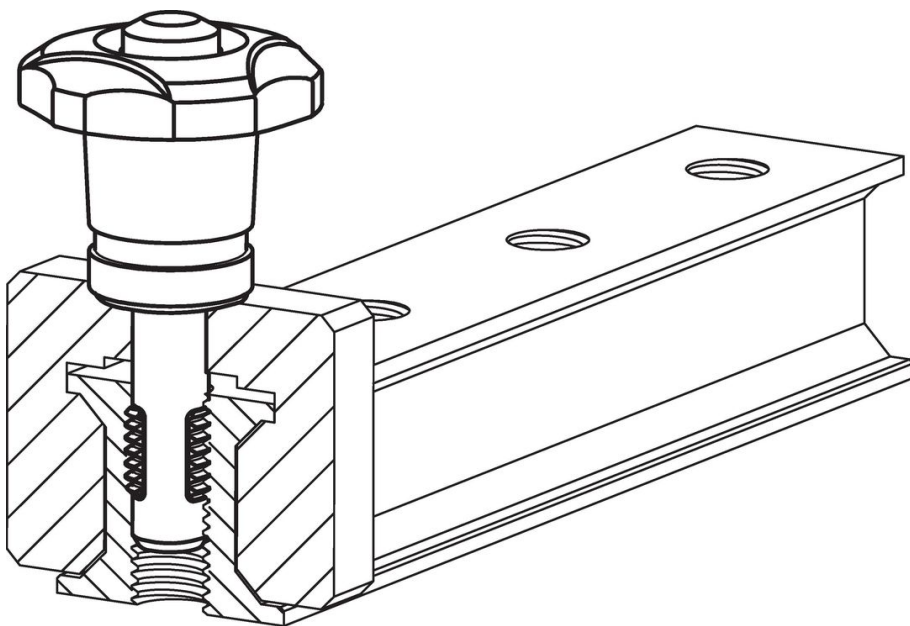

遵守

符合 RoHS

含铅 - 符合例外 6a / 6b / 6c

含有 >0.1% w/w 的 SVHC 物质

含铅 - SVHC [REACH] 清单截至 2024 年 6 月 27 日

包含 65 号提案的物质



铅暴露会导致癌症和生殖伤害

<https://www.P65Warnings.ca.gov/>

不含冲突矿物

„本产品不含来自刚果民主共和国或邻近国家的任何被指定为“冲突矿物”的物质，例如钽、锡、金或钨。