

Kugeldruckschrauben · ohne Kopf, volle Kugel

EH 22720.



Produktbeschreibung

Kugeldruckschrauben mit Thermoplast-Kugel sind für spröde, druckempfindliche Teile geeignet. Kugeldruckschrauben können zum Positionieren und Klemmen, Spannen oder Stützen auch von nicht parallelen Flächen verwendet werden.

Werkstoff

Kugel

- Kugellagerstahl, gehärtet
- Rostfreier Stahl, gehärtet
- Thermoplast POM, weiß

Schraube

- Vergütungsstahl, 1200 ±100 N/mm²
- Rostfreier Stahl 1.4305

Weiterführende Informationen

Hinweise

Kugel nicht gegen Verdrehen gesichert.
Sonderausführung auf Anfrage.

Verweise

Gewindesicherung auf Anfrage, siehe Anhang
- Technische Daten -

Weitere Produkte

- Kugeldruckschrauben, ohne Kopf, mit Feingewinde
- Kugeldruckschrauben, ohne Kopf, volle Kugel und Innensechsrund

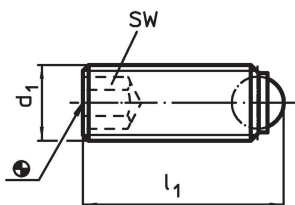

Maßzeichnung





Bestellinformationen

d ₁	Abmessungen		Kugeldurchmesser	SW	Belastbarkeit bei statischer Belastung ¹⁾ max.	Temperaturbereich		Gewicht	Art.-Nr.
	l ₁	[mm]				min.	max.		
volle Kugel, Vergütungsstahl									
M 3	5,0		1,5	1,5	2,5	–	250	0,1	22720.0032
M 3	7,5		1,5	1,5	2,5	–	250	0,2	22720.0033
M 3	10,0		1,5	1,5	2,5	–	250	0,3	22720.0034
M 4	6,0		2,5	2,0	3,5	–	250	0,3	22720.0042
M 4	8,0		2,5	2,0	3,5	–	250	0,4	22720.0043
M 4	10,0		2,5	2,0	3,5	–	250	0,5	22720.0044
M 4	12,0		2,5	2,0	3,5	–	250	0,7	22720.0045
M 4	16,0		2,5	2,0	3,5	–	250	1,0	22720.0046
M 5	8,0		3,0	2,5	4,5	–	250	0,7	22720.0052
M 5	10,0		3,0	2,5	4,5	–	250	0,9	22720.0053
M 5	12,0		3,0	2,5	4,5	–	250	1,1	22720.0054
M 5	16,0		3,0	2,5	4,5	–	250	1,6	22720.0055
M 5	20,0		3,0	2,5	4,5	–	250	2,0	22720.0056
M 5	25,0		3,0	2,5	4,5	–	250	2,6	22720.0058
M 6	10,8		4,0	3,0	9,0	–	250	1,3	22720.0062
M 6	12,8		4,0	3,0	9,0	–	250	1,7	22720.0063
M 6	16,8		4,0	3,0	9,0	–	250	2,3	22720.0064
M 6	20,8		4,0	3,0	9,0	–	250	3,0	22720.0065
M 6	25,8		4,0	3,0	9,0	–	250	3,8	22720.0066
M 8	11,2		5,5	4,0	15,0	–	250	2,5	22720.0081
M 8	13,2		5,5	4,0	15,0	–	250	2,8	22720.0082
M 8	17,2		5,5	4,0	15,0	–	250	4,0	22720.0083



¹⁾ Belastbarkeitsangaben gelten nicht für Ausführungen aus rostfreiem Stahl (ausgenommen bei Ausführungen mit Thermoplast-Kugel).

d ₁	Abmessungen		SW	Belastbarkeit bei statischer Belastung ¹⁾ max.	 min. — max.		 [g]	Art.-Nr.
	l ₁	Kugeldurch- messer			[mm]	[kN]		
M 8	21,2	5,5	4,0	15,0	–	250	5,2	22720.0084
M 8	26,2	5,5	4,0	15,0	–	250	6,7	22720.0085
M 8	31,2	5,5	4,0	15,0	–	250	8,3	22720.0086
M10	13,7	7,0	5,0	20,0	–	250	4,7	22720.0101
M10	17,7	7,0	5,0	20,0	–	250	6,0	22720.0102
M10	21,7	7,0	5,0	20,0	–	250	8,0	22720.0103
M10	26,7	7,0	5,0	20,0	–	250	10,0	22720.0104
M10	31,7	7,0	5,0	20,0	–	250	13,0	22720.0105
M10	36,7	7,0	5,0	20,0	–	250	15,0	22720.0106
M10	41,7	7,0	5,0	20,0	–	250	18,0	22720.0108
M12	18,0	8,5	6,0	30,0	–	250	9,2	22720.0121
M12	22,0	8,5	6,0	30,0	–	250	11,0	22720.0122
M12	27,0	8,5	6,0	30,0	–	250	14,0	22720.0123
M12	32,0	8,5	6,0	30,0	–	250	18,0	22720.0124
M12	42,0	8,5	6,0	30,0	–	250	25,0	22720.0126
M12	52,0	8,5	6,0	30,0	–	250	32,0	22720.0128
M16	23,3	12,0	8,0	60,0	–	250	22,0	22720.0161
M16	28,3	12,0	8,0	60,0	–	250	27,0	22720.0162
M16	38,3	12,0	8,0	60,0	–	250	41,0	22720.0164
M16	53,3	12,0	8,0	60,0	–	250	61,0	22720.0166
M20	34,2	15,0	10,0	90,0	–	250	52,0	22720.0202
M20	44,2	15,0	10,0	90,0	–	250	73,0	22720.0204
M20	54,2	15,0	10,0	90,0	–	250	94,0	22720.0205
M20	64,2	15,0	10,0	90,0	–	250	114,0	22720.0206
M24	39,7	18,0	12,0	120,0	–	250	89,0	22720.0242
M24	54,7	18,0	12,0	120,0	–	250	133,0	22720.0244
M24	84,7	18,0	12,0	120,0	–	250	223,0	22720.0246
volle Kugel, Rostfreier Stahl								
M 3	5,0	1,5	1,5	2,5	–	250	0,1	22720.0747
M 3	7,5	1,5	1,5	2,5	–	250	0,2	22720.0748
M 3	10,0	1,5	1,5	2,5	–	250	0,3	22720.0749
M 4	6,0	2,5	2,0	3,5	–	250	0,3	22720.0750
M 4	8,0	2,5	2,0	3,5	–	250	0,4	22720.0752
M 4	10,0	2,5	2,0	3,5	–	250	0,5	22720.0754
M 4	12,0	2,5	2,0	3,5	–	250	0,7	22720.0756
M 4	16,0	2,5	2,0	3,5	–	250	1,0	22720.0758
M 5	8,0	3,0	2,5	4,5	–	250	0,7	22720.0760
M 5	10,0	3,0	2,5	4,5	–	250	0,9	22720.0761
M 5	12,0	3,0	2,5	4,5	–	250	1,1	22720.0762
M 5	16,0	3,0	2,5	4,5	–	250	1,6	22720.0763
M 5	20,0	3,0	2,5	4,5	–	250	2,0	22720.0764
M 5	25,0	3,0	2,5	4,5	–	250	2,6	22720.0765
M 6	10,8	4,0	3,0	9,0	–	250	1,3	22720.0770
M 6	12,8	4,0	3,0	9,0	–	250	1,7	22720.0772
M 6	16,8	4,0	3,0	9,0	–	250	2,3	22720.0774
M 6	20,8	4,0	3,0	9,0	–	250	3,0	22720.0775
M 6	25,8	4,0	3,0	9,0	–	250	3,8	22720.0776
M 8	11,2	5,5	4,0	15,0	–	250	2,5	22720.0780
M 8	13,2	5,5	4,0	15,0	–	250	2,8	22720.0782
M 8	17,2	5,5	4,0	15,0	–	250	4,0	22720.0783
M 8	21,2	5,5	4,0	15,0	–	250	5,2	22720.0784
M 8	26,2	5,5	4,0	15,0	–	250	6,7	22720.0785
M 8	31,2	5,5	4,0	15,0	–	250	8,3	22720.0786
M10	13,7	7,0	5,0	20,0	–	250	4,7	22720.0790
M10	17,7	7,0	5,0	20,0	–	250	6,0	22720.0792
M10	21,7	7,0	5,0	20,0	–	250	8,0	22720.0793
M10	26,7	7,0	5,0	20,0	–	250	10,0	22720.0794
M10	31,7	7,0	5,0	20,0	–	250	13,0	22720.0795
M10	36,7	7,0	5,0	20,0	–	250	15,0	22720.0796

¹⁾ Belastbarkeitsangaben gelten nicht für Ausführungen aus rostfreiem Stahl (ausgenommen bei Ausführungen mit Thermoplast-Kugel).

d ₁	Abmessungen		SW	Belastbarkeit bei statischer Belastung ¹⁾ max.	 min. — max.		 [g]	Art.-Nr.
	l ₁	Kugeldurch- messer			[mm]	[kN]		
M10	41,7	7,0	5,0	20,0	–	250	18,0	22720.0798
M12	18,0	8,5	6,0	30,0	–	250	9,2	22720.0800
M12	22,0	8,5	6,0	30,0	–	250	11,0	22720.0802
M12	27,0	8,5	6,0	30,0	–	250	14,0	22720.0803
M12	32,0	8,5	6,0	30,0	–	250	18,0	22720.0804
M12	42,0	8,5	6,0	30,0	–	250	25,0	22720.0806
M12	52,0	8,5	6,0	30,0	–	250	32,0	22720.0808
M16	23,3	12,0	8,0	60,0	–	250	22,0	22720.0810
M16	28,3	12,0	8,0	60,0	–	250	27,0	22720.0812
M16	38,3	12,0	8,0	60,0	–	250	41,0	22720.0814
M16	53,3	12,0	8,0	60,0	–	250	61,0	22720.0816
volle Kugel aus Thermoplast, Rostfreier Stahl								
M 4	6,0	2,5	2,0	0,3	-30	80	0,2	22720.0252
M 4	8,0	2,5	2,0	0,3	-30	80	0,4	22720.0253
M 4	10,0	2,5	2,0	0,3	-30	80	0,5	22720.0254
M 4	12,0	2,5	2,0	0,3	-30	80	0,6	22720.0255
M 4	16,0	2,5	2,0	0,3	-30	80	0,9	22720.0256
M 5	8,0	3,0	2,5	0,5	-30	80	0,8	22720.0262
M 5	10,0	3,0	2,5	0,5	-30	80	0,7	22720.0263
M 5	12,0	3,0	2,5	0,5	-30	80	1,0	22720.0264
M 5	16,0	3,0	2,5	0,5	-30	80	1,5	22720.0265
M 5	20,0	3,0	2,5	0,5	-30	80	1,9	22720.0266
M 5	25,0	3,0	2,5	0,5	-30	80	2,5	22720.0267
M 6	10,8	4,0	3,0	0,9	-30	80	1,1	22720.0272
M 6	12,8	4,0	3,0	0,9	-30	80	1,4	22720.0273
M 6	16,8	4,0	3,0	0,9	-30	80	2,1	22720.0274
M 6	20,8	4,0	3,0	0,9	-30	80	2,8	22720.0275
M 6	25,8	4,0	3,0	0,9	-30	80	3,6	22720.0276
M 8	11,2	5,5	4,0	1,5	-30	80	1,9	22720.0281
M 8	13,2	5,5	4,0	1,5	-30	80	2,3	22720.0282
M 8	17,2	5,5	4,0	1,5	-30	80	3,6	22720.0283
M 8	21,2	5,5	4,0	1,5	-30	80	4,6	22720.0284
M 8	26,2	5,5	4,0	1,5	-30	80	6,3	22720.0285
M 8	31,2	5,5	4,0	1,5	-30	80	7,7	22720.0286
M10	13,7	7,0	5,0	2,0	-30	80	3,5	22720.0291
M10	17,7	7,0	5,0	2,0	-30	80	4,9	22720.0292
M10	21,7	7,0	5,0	2,0	-30	80	6,8	22720.0293
M10	26,7	7,0	5,0	2,0	-30	80	9,2	22720.0294
M10	31,7	7,0	5,0	2,0	-30	80	12,0	22720.0295
M10	36,7	7,0	5,0	2,0	-30	80	14,0	22720.0296
M10	41,7	7,0	5,0	2,0	-30	80	16,0	22720.0297
M12	18,0	8,5	6,0	3,0	-30	80	7,1	22720.0301
M12	22,0	8,5	6,0	3,0	-30	80	8,8	22720.0302
M12	27,0	8,5	6,0	3,0	-30	80	12,0	22720.0303
M12	32,0	8,5	6,0	3,0	-30	80	16,0	22720.0304
M12	42,0	8,5	6,0	3,0	-30	80	23,0	22720.0306
M12	52,0	8,5	6,0	3,0	-30	80	30,0	22720.0308
volle Kugel aus Thermoplast, Vergütungsstahl								
M 4	6,0	2,5	2,0	0,3	-30	80	0,2	22720.0342
M 4	8,0	2,5	2,0	0,3	-30	80	0,4	22720.0343
M 4	10,0	2,5	2,0	0,3	-30	80	0,5	22720.0344
M 4	12,0	2,5	2,0	0,3	-30	80	0,6	22720.0345
M 4	16,0	2,5	2,0	0,3	-30	80	0,9	22720.0346
M 5	8,0	3,0	2,5	0,5	-30	80	0,8	22720.0352
M 5	10,0	3,0	2,5	0,5	-30	80	0,7	22720.0353
M 5	12,0	3,0	2,5	0,5	-30	80	1,0	22720.0354
M 5	16,0	3,0	2,5	0,5	-30	80	1,5	22720.0355
M 5	20,0	3,0	2,5	0,5	-30	80	1,9	22720.0356
M 5	25,0	3,0	2,5	0,5	-30	80	2,5	22720.0358

¹⁾ Belastbarkeitsangaben gelten nicht für Ausführungen aus rostfreiem Stahl (ausgenommen bei Ausführungen mit Thermoplast-Kugel).

d ₁	Abmessungen		SW [mm]	Belastbarkeit bei statischer Belastung ¹⁾ max. [kN]	 min. max. [°C]		 [g]	Art.-Nr.
	l ₁ [mm]	Kugeldurch- messer						
M 6	10,8	4,0	3,0	0,9	-30	80	1,1	22720.0362
M 6	12,8	4,0	3,0	0,9	-30	80	1,4	22720.0363
M 6	16,8	4,0	3,0	0,9	-30	80	2,1	22720.0364
M 6	20,8	4,0	3,0	0,9	-30	80	2,8	22720.0365
M 6	25,8	4,0	3,0	0,9	-30	80	3,6	22720.0366
M 8	11,2	5,5	4,0	1,5	-30	80	1,9	22720.0381
M 8	13,2	5,5	4,0	1,5	-30	80	2,3	22720.0382
M 8	17,2	5,5	4,0	1,5	-30	80	3,6	22720.0383
M 8	21,2	5,5	4,0	1,5	-30	80	4,6	22720.0384
M 8	26,2	5,5	4,0	1,5	-30	80	6,3	22720.0385
M 8	31,2	5,5	4,0	1,5	-30	80	7,7	22720.0386
M10	13,7	7,0	5,0	2,0	-30	80	3,5	22720.0401
M10	17,7	7,0	5,0	2,0	-30	80	4,9	22720.0402
M10	21,7	7,0	5,0	2,0	-30	80	6,8	22720.0403
M10	26,7	7,0	5,0	2,0	-30	80	9,2	22720.0404
M10	31,7	7,0	5,0	2,0	-30	80	12,0	22720.0405
M10	36,7	7,0	5,0	2,0	-30	80	14,0	22720.0406
M10	41,7	7,0	5,0	2,0	-30	80	16,0	22720.0408
M12	18,0	8,5	6,0	3,0	-30	80	7,1	22720.0421
M12	22,0	8,5	6,0	3,0	-30	80	8,8	22720.0422
M12	27,0	8,5	6,0	3,0	-30	80	12,0	22720.0423
M12	32,0	8,5	6,0	3,0	-30	80	16,0	22720.0424
M12	42,0	8,5	6,0	3,0	-30	80	23,0	22720.0426
M12	52,0	8,5	6,0	3,0	-30	80	30,0	22720.0428

¹⁾ Belastbarkeitsangaben gelten nicht für Ausführungen aus rostfreiem Stahl (ausgenommen bei Ausführungen mit Thermoplast-Kugel).

Anwendungsbeispiel

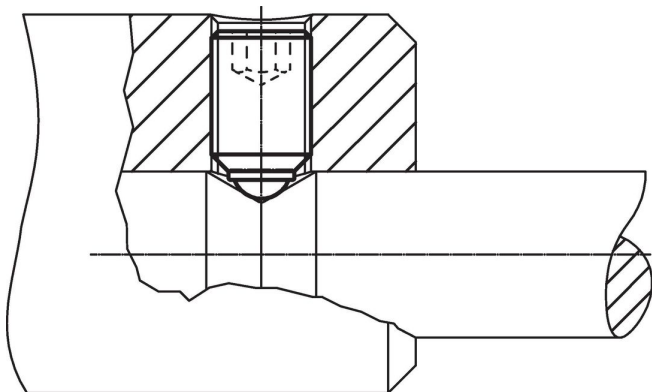

Compliance

Für detaillierte Compliance Informationen wählen Sie bitte die gewünschte Artikelnummer.